

Noise measurements of the low T_c MgB₂ HEB mixer at 1.6THz and 2.6THz

Evgenii Novoselov^{1,*}, Stella Bevilacqua¹, Sergey Cherednichenko¹, Hiroyuki Shibata² and Yasuhiro Tokura²

¹Chalmers University of Technology, Gothenburg, Sweden

²NTT Basic Research Laboratories, NTT Corporation, Japan

*Contact: evgenii@chalmers.se, phone +46-31-772 1849

Abstract— We present results on MgB₂ hot-electron bolometer noise measurements to show reproducibility of achieved results and robustness of the fabricated devices, which being passivated with silicon nitride shows the same performance after 1.5 year storing in nitrogen atmosphere. Noise temperature measurements were performed for the HEB made of 10nm MgB₂ thin film on Al₂O₃ with T_c of 8.5K for 1.6THz LO at 2.7K and 4.2K. The minimum double side band noise temperatures corrected for optical losses for different bath temperatures were 700K and 1150K, whereas the noise bandwidth was 3.2GHz and 3.5GHz, respectively. The mixer output noise temperature and the conversion gain were 26K and -17.7dB, 27K and -14.9dB, respectively. For 2.6THz LO at 2.7K the corresponding values are 1200K and 3.7GHz.

I. INTRODUCTION

The part of the electromagnetic wave spectrum of 0.1-10 THz (3 mm – 30 μ m), so called terahertz (THz) range [1], is of great interest for radio astronomy because it covers rotational lines from simple molecules and the ground state fine-structure lines from abundant atoms and ions [2], which allows to observe star-formation activities, physics and chemistry of the interstellar medium, spectroscopic and photometric study of comets, asteroids and outer planet atmospheres and their satellites [3]. Several programs for space observation involving THz range were launched in recent years: ALMA [4], APEX [5], Herschel [6], SOFIA [7], etc.

In the THz range, heterodyne receivers are required in order to achieve a high spectral resolution ($>10^6$). Several types of devices were proposed to use as a mixing element for THz range: Schottky diodes, SIS junctions, hot-electron bolometers (HEBs). The first two types of mixer have some disadvantages: Schottky diodes have a comparatively high noise temperature and high local oscillator (LO) power requirements, but work at room temperature [8], whereas SIS mixers have high-frequency limitations, <1.3 THz [9].

The discovery of electron-heating effect in superconducting films [10] led to the development of new class of low-noise heterodyne receivers based on superconducting hot-electron bolometers (HEBs) mixers [11]. Until recently, the state of the art phonon-cooled HEBs were fabricated using NbN ultrathin films providing a rather low receiver noise temperature down to 750K and 950K for 1.6THz and 1.9THz LO frequency,

respectively [12]. This frequencies correspond to the band 6-7 of the Herschel's HIFI instrument and allow to detect emission lines of different molecules. For the phonon-cooled NbN HEB mixers 3-4GHz gain bandwidth was achieved. The discovery of superconductivity in MgB₂ [13] with a highest critical temperature among intermetallic compounds ($T_c=39$ K) and recent progress in ultrathin film deposition [14, 15] opened new opportunities in HEB development [16-19]. Previously we reported the minimum mixer noise temperature of 600K at 2K and 3.4 GHz gain bandwidth at 4.2K for an LO frequency of 0.6 THz and mixer noise temperature of 1150K with 2.2-2.5 GHz noise bandwidth for 1.6 THz LO frequency in HEBs made from films grown on Al₂O₃ by MBE [16,17,19]. The gain bandwidth up to 8 GHz for an 0.6 THz LO frequency was demonstrated by other group for HEBs made from HPCVD grown films on SiC [18].

In this paper we present our results on low T_c MgB₂ HEB mixer noise measurements. The device fabricated 1.5 year ago was tested at 1.6THz LO frequency to check reproducibility of the results presented in paper [19]. In addition, the first measurements of noise temperature at 2.6THz were performed.

II. DEVICE FABRICATION AND MEASUREMENT SET-UP

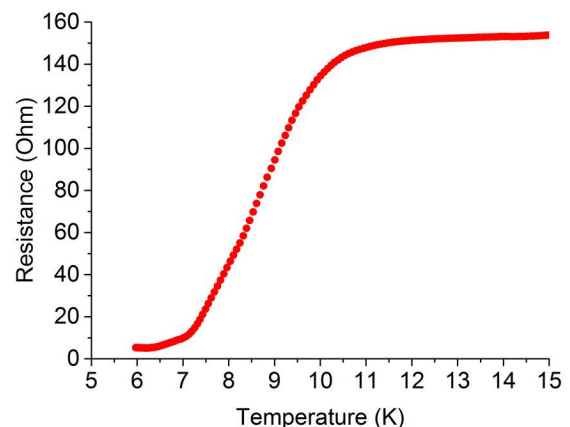

Fig. 1 Resistance versus temperature dependence for the tested device.

For the HEB fabrication a thin 10nm MgB₂ film was used. It was deposited on a c-cut sapphire substrate using molecular-

beam epitaxy (MBE) and covered *in-situ* with a 20nm gold layer to prevent film degradation and to reduce contact resistance between the MgB₂ film and the metal layers deposited later. The HEB was fabricated using e-beam lithography and argon ion beam milling in several steps. For radiation coupling into the bolometer a broadband planar spiral antenna was made of 270nm gold film in the same process. Devices were passivated with a 40nm SiN_x layer in purpose of protection from degradation due to oxidation and exposure to water [20]. The HEB discussed below was 1x1um² in size, with a critical temperature of 8.5K, a transition width of 2.5K, and a room temperature resistance of 160Ω. The R-T curve measured in a deep-stick is presented on Fig. 1.

TABLE I
LOSSES AND EQUIVALENT NOISE TEMPERATURES OF ALL OPTICAL COMPONENTS AT 1.6THZ

Component	T (K)	L (dB)	T _{eq} (K)
Air path	295	1	76.4
Beam splitter	295	0.1	7.0
Cryostat's window	295	0.7	52.5
IR filter	4.2	0.6	0.6
Si lens	4.2	1	1.1
Total	-	3.4	137.6

The measurement set-up is presented in Fig. 2. Noise measurements were performed at a 1.6THz and a 2.6THz local oscillator frequencies (LO) (a far-infrared (FIR) gas laser) at bath temperatures of 4.2K and 2.7K (the later achieved by helium vapor pumping). The HEB was mounted in a mixer block with a 12mm Si lens and placed in front of the liquid He

cryostat's HDPE window (0.7dB loss). A Zitex™ IR filter was placed on the 4K shield of the cryostat (0.6dB loss). A bias-T followed the mixer block to apply the voltage bias to the device and to separate the intermediate frequency (IF) response. Several amplifiers were used in the IF chain to measure the IF response: a Chalmers 2-4GHz InP low-noise amplifier mounted on the cryostats' cold plate at 4.2K or 2.7K, a Chalmers 2-4GHz GaAs low-noise amplifier at room temperature outside the cryostat and a broadband MITEQ amplifier at the end. A 3dB attenuator was placed between the cryostat and the first room temperature LNA to reduce a standing wave formation in the long IF cable. The amplified signal was measured through a tunable YIG-filter (50MHz bandwidth) with a power meter. A Mylar beam splitter (of either 12 um or 3 mm thick) were used to combine LO and the signal (from the hot/cold loads) beams. The idea behind using different beam splitters was to find a balance between the reflection and the transmission coefficients to provide the LO power high enough to pump the device into the stable operation mode. A Golay cell connected to an oscilloscope was placed behind the beam splitter to monitor the FIR gas laser emission power during experiments.

To define the double side band (DSB) receiver noise temperature T_{rec} the Y-factor technique was used. Y-factor is a ratio of the receiver output power with the hot and the cold loads (in our case 295K and 77K, respectively):

$$Y = \frac{P_{hot}}{P_{cold}} = \frac{T_{rec} + T(295K)}{T_{rec} + T(77K)}$$

Then:

$$T_{rec} = \frac{T(295K) - Y * T(77K)}{Y - 1}$$

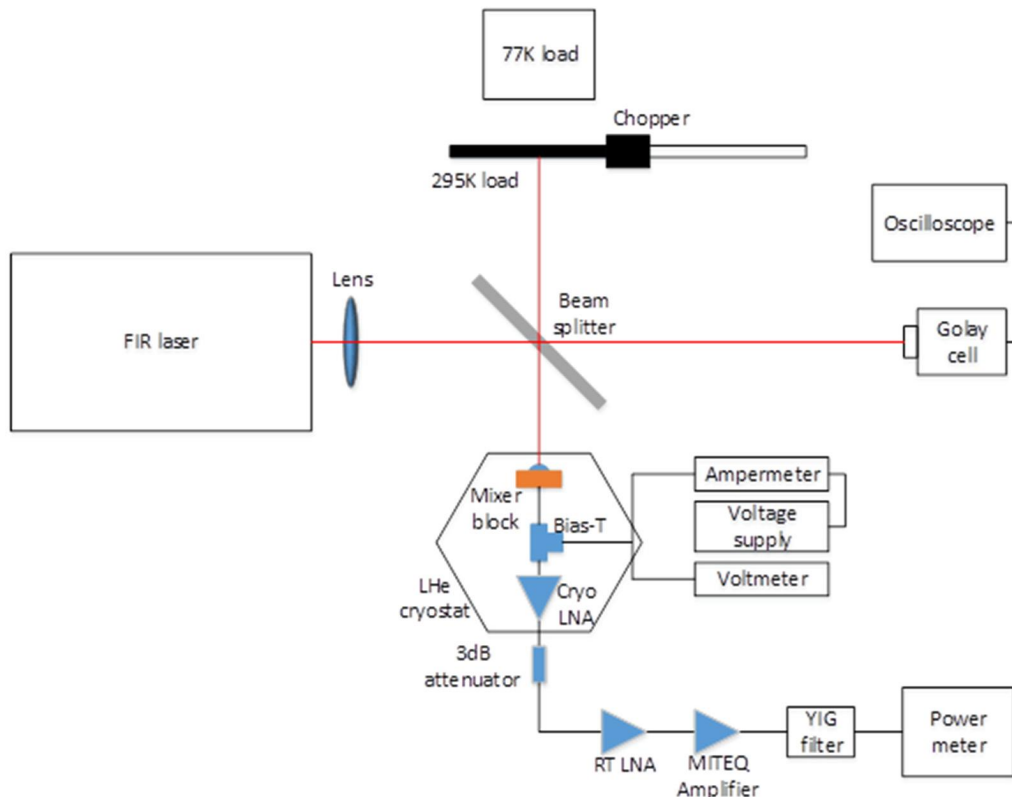

Fig 2. Noise measurement setup.

The optical losses (the beam splitter, the window, the IR filter, and the air propagation loss due to water vapour absorption) can be subtracted from the noise temperature.

In order to measure the HEB conversion gain and the output noise temperature, the U-factor technique was applied [19]. Usually, the U-factor is defined as a ratio of the receiver output (IF) power when the receiver is in the operating state to the one in the superconducting state. In our case we have modified this method due to the absence of an isolator between the device and the LNA. Considering that the impedance of the HEB changes from 0Ω (superconducting state) to 160Ω (normal state), the LNA gain and the noise is expected to change. We have experimentally evaluated the difference of the LNA gain in matched and unmatched state to be up to 2.6dB.

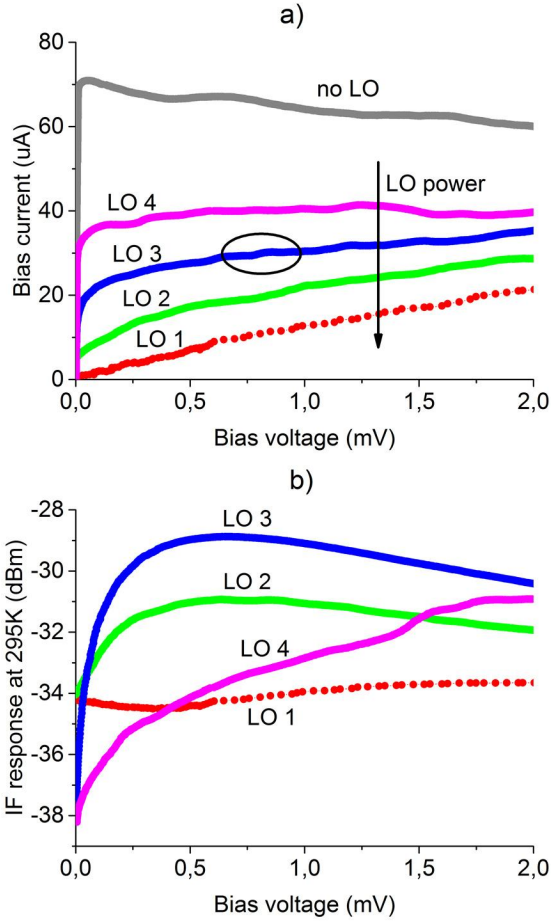

Fig 3. (a) I-V curves under different LO (1.6THz) power, optimal operation points marked with a black ellipse and (b) the corresponding IF response at 295K load at 1.8GHz IF.

To reduce this effect the normal state of the HEB device was used instead of the superconducting state as a reference point. The normal state could be achieved by a heavy pumping of HEB with LO. With the HEB in the normal state its output power is determined mostly by the thermal noise with an effective temperature, which is equal to the electron temperature of the HEB in this state (i.e. about T_c) [19]. In this case, the output power of the receiver is determined by a sum of the HEB and the LNA noise temperatures – $T_{LNA} + T_c$:

$$U = \frac{T_{rec} + T(295K)}{T_{LNA} + T_c} \frac{2}{L_{tot}}$$

where T_{LNA} is the IF chain noise temperature, T_c is the HEB critical temperature, and L_{tot} is the receiver conversion loss ($L_{tot} = L_{opt} * L_m$; L_{opt} the optical loss, L_m the mixer conversion loss). The factor “2” in the equation comes from the DSB operation of the bolometer mixer and an assumption that the sideband ratio is 1:

$$L_{tot} = \frac{2(T_{rec} + T(295K))}{U(T_{LNA} + T_c)}$$

The equation for the U-factor could be modified to:

$$U = \frac{T_{out} + T_{LNA} + \frac{2(T_{RF} + T(295K))}{L_{tot}}}{T_{LNA} + T_c}$$

where T_{out} is the mixer output noise temperature, T_{RF} is the noise contribution of optical components. Calculated equivalent noise temperatures of all optical components are presented in Table I.

Finally, for the mixer output noise temperature becomes:

$$T_{out} = U(T_{LNA} + T_c) - T_{LNA} - 2 \frac{T(295K)}{L_{tot}} - 2 \frac{T_{RF}}{L_{tot}}$$

III. RESULTS AND DISCUSSION

The I-V curves of the device at 4.2K (with and without LO pumping) and the corresponding IF response versus the bias voltage curves (at the 295K load) are presented in Fig. 3. The required LO power to reach the minimum receiver noise temperature (LO3) was 70nW as was calculated using an isotherm method with an assumption that both the direct current (DC) and the LO power have the same effect on the bolometer resistance [21]. The LO power required for operation in optimal point is lower than that was reported for NbN HEB mixers taking in account device volume.

The DSB receiver noise temperatures versus the intermediate frequency for different operation points are presented in Fig. 4.

The input noise temperature of the mixer including the IF chain can be written as:

$$T_m(f_{if}) = \frac{T_J + T_{TF} + T_{LNA}}{G_m(0) \left(1 + \left(\frac{f_{if}}{f_g}\right)^2\right)^{-1}}$$

where T_J , T_{TF} are the Johnson noise and the thermal fluctuation noise at the HEB output, $G_m(0)$ is the intrinsic mixer conversion gain at zero IF, and f_g is the HEB 3dB gain roll-off frequency (the gain bandwidth). The thermal fluctuation noise depends on the IF frequency as $(1 + (2\pi f_{if} \tau_\theta)^2)^{-1}$, where τ_θ is the electron temperature relaxation time. Since τ_θ and mixer time constant $\tau_{mix} = 1/2\pi f_g$ are typically close values at the optimal operation point, the equation could be rewritten:

$$T_m(f_{if}) = \frac{T_{TF} + (T_J + T_{LNA}) \left(1 + \left(\frac{f_{if}}{f_g}\right)^2\right)}{G_m(0)}$$

and then, defining the new parameter f_N as the mixer noise bandwidth:

$$f_N = f_g \sqrt{\frac{T_J + T_{TF} + T_{LNA}}{T_J + T_{LNA}}}$$

the final equation becomes:

$$T_m(f_{if}) = T_m(0) \left[1 + \left(\frac{f_{if}}{f_N}\right)^2\right]$$

where $T_m(0)$ is the mixer noise temperature at zero IF frequency. Fitting the corrected DSB noise temperature acquired with the Y-factor measurement by the above equation, both $T_m(0)$ and the f_N can be obtained as 1150K and 3.5GHz. The minimum measured DSB noise temperature was 1100K at 1.4GHz IF frequency.

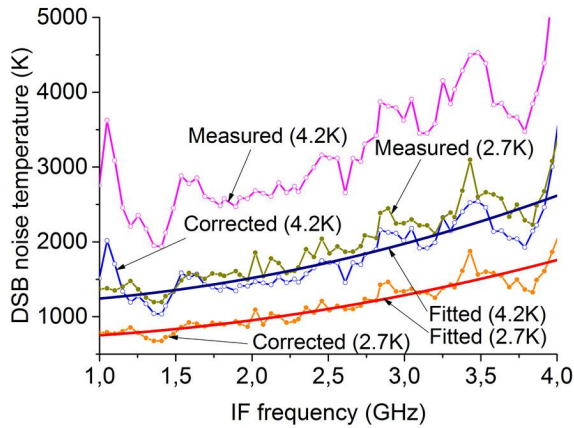

Fig 4. Measured and corrected (for optical losses) DSB receiver noise temperatures versus frequency at 4.2K and 2.7K for 1.6THz LO. The bias points are $U_0=0.8\text{mV}$ $I_0=28\mu\text{A}$ and $U_0=1.3\text{mV}$ $I_0=28\mu\text{A}$, beam splitter used are 12um and 3um Mylar, respectively.

From Figs. 4 and 3(b) the mixer conversion gain and the output noise temperature can be calculated. The noise temperature of the IF chain is defined mostly by the noise temperature of the first amplifier in the chain, which is mounted on the cryostat's cold plate and it has a 30dB gain and a noise temperature of around 2K. Since the noise temperature of the rest part of IF chain was 350K one can estimate the noise temperature of our IF chain not exceeding 3K. Since the IF response at the optimal operation point of $U_0=0.8\text{mV}$ and $I_0=28\mu\text{A}$ (LO3 curve on Fig. 3 (b)) is -28.9dBm and considering the normal state (LO1 curve on Fig.3 (b)) response of -33.8dBm, one can get a mixer conversion gain of $-17.7\pm 1.2\text{dB}$ and an output noise temperature of $26\pm 1\text{K}$.

Since the T_c of the used HEB mixer was quite low, the receiver noise temperature was also measured at the bath temperature of 2.7K, achieved by reducing the pressure above LHe. Simultaneously, the beam splitter was changed to 3um Mylar film, which all together resulted in a 35% increase in the HEB critical current and a 40% reduction of the receiver noise temperature (Fig. 4). But still the LO power was enough to pump the device into the normal state and to perform U-factor measurements. The I-V curves of the device under LO pumping at 2.7K and the corresponding IF response curves at the 295K load are presented in Fig. 5. The optimal operation region moved to higher bias voltages. The required LO power calculated with the same isothermal method was 80nW.

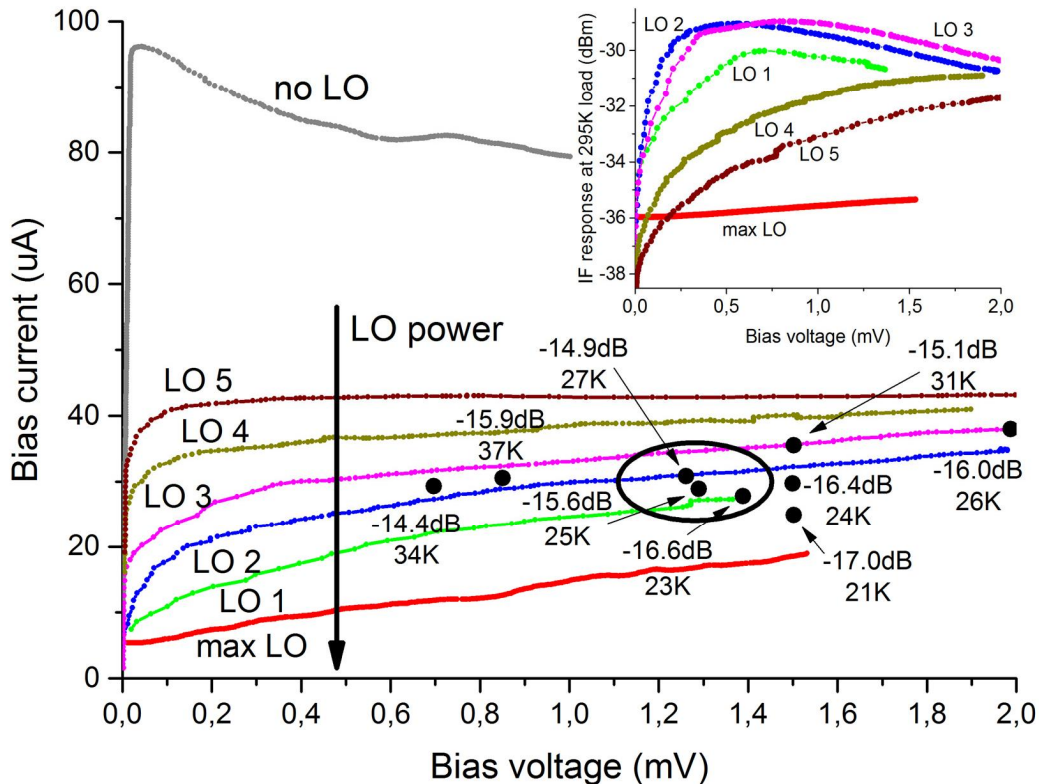

Fig 5. I-V curves under different LO power at 2.7K and 1.6THz LO, optimal operation points marked with the black ellipse. The corresponding IF response at 295K load at 1.4 GHz is shown in the insert.

The IF response for the optimal operation point of $U_0=1.3\text{mV}$ and $I_0=28\mu\text{A}$ of -29.9dBm now became lower than at 4.2K and for the normal state (LO2 curve on Fig. 5(insert)) -35.6dBm , which results in a $-14.9\pm 1.1\text{dB}$ mixer conversion gain and a $27\pm 1\text{K}$ noise temperature. Mixers conversion gain became higher, but the output mixer noise temperature left almost the same. The conversion gain and output mixer noise temperature were calculated for several bias points and are shown in Fig. 5.

The as-measured and the corrected for optical losses DSB noise temperatures versus the intermediate frequency for the optimal operation point at 2.7K are presented on Fig. 4.

The corrected DSB noise temperature curve is fitted with the same equation as for 4.2K with a 700K zero IF noise temperature and a 3.2GHz noise bandwidth. The measured noise temperature at 2.7K is much lower than at 4.2 , but the noise bandwidth is reduced insignificantly.

Y-factor measurements were also performed at 2.6THz LO and 2.7K bath temperature. The available LO power at this frequency was lower but still enough to pump the device into the operation mode. The I-V-curve of the device pumped with LO and the IF response at 295K load are plotted on a Fig. 6.

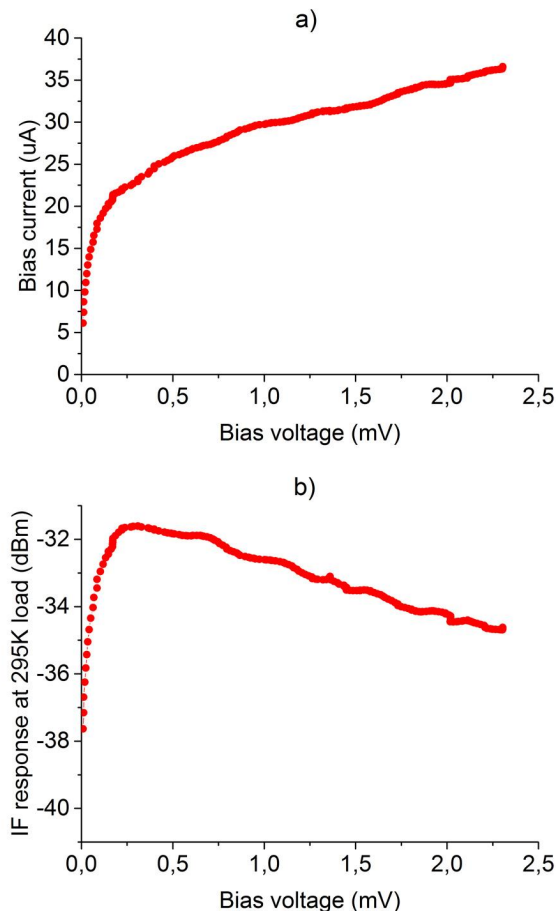

Fig 6. (a) I-V curves under LO pumping at 2.7K and 2.6THz LO and (b) corresponding IF noise power from the 295K load at 1.8GHz .

The DSB receiver noise temperature versus the intermediate frequency for one operation point of $U_0=1.38\text{mV}$ and $I_0=31\mu\text{A}$ at 2.7K is presented on Fig. 7. This curve could be fitted with a previously used equation, which leads to a zero IF frequency noise temperature T_m of 1400K and a 3.7GHz noise bandwidth.

It is problematic to calculate the mixer conversion gain, because the LO power at 2.6THz was not enough to pump the device into the normal state, and U-factor measurements using the superconductive state are not completely faithful due to the absence of the isolator between the mixer block and the LNA, which causes a change of the gain and the noise temperature of LNA because of mismatch.

For 2.6THz LO the DSB noise temperature for the device appears to be higher compared to the 1.6THz LO, but probably the optimal operation point was not achieved. Further investigation for this frequency is required.

IV. CONCLUSIONS

We have tested an MgB_2 hot-electron bolometer mixer at both 1.6THz and 2.6THz LO at both 4.2K and 2.7K bath temperatures. The device had a T_c of 8.5K , which is quite low for MgB_2 thin films. Recently, results on HEB mixers with T_c of $35\text{--}38\text{K}$ made of $10\text{--}20\text{nm}$ films produced using HPCVD method were reported [22].

The minimum measured noise temperature, the noise temperature at zero IF frequency and the noise bandwidth, the output mixer noise temperature and the mixer conversion gain of the tested device are summarized in Table II. At 1.6THz LO a reduction of the bath temperature leads to a reduction of the receiver noise temperature, due to the reduction of mixer conversion gain (caused probably by an increased LO power), but also to a slight reduction of noise bandwidth. An estimated increase of the required LO power in this case was about 13% . The output mixer noise temperature stays almost the same in this case but the mixer conversion gain increases.

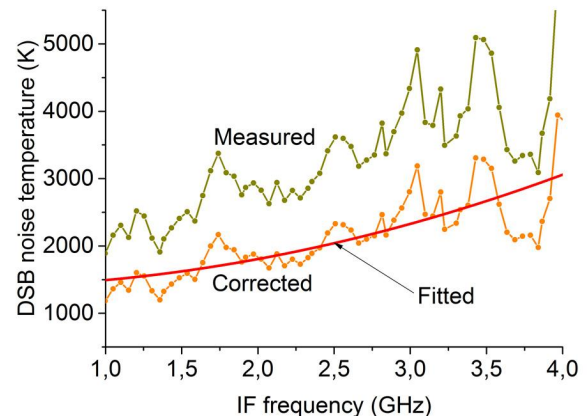

Fig 7. Measured and corrected for optical losses DSB receiver noise temperature versus frequency at 2.7K and 2.6THz LO. Bias point $U_0=1.38\text{mV}$ $I_0=31\mu\text{A}$. $3\mu\text{m}$ Mylar beam splitter.

TABLE II
MEASURED AND CALCULATED RECEIVER PARAMETERS FOR 1.6THz AND 2.6THz AT 4.2K AND 2.7K

LO (THz)	T_{bath} (K)	$T_m(0)$ (K)	f_N (GHz)	T_{out} (K)	G_m (dB)
1.6	2.7	700	3.2	27	-14.9
1.6	4.2	1150	3.5	26	-17.7
2.6	2.7	1400	3.7	-	-

Further study of the noise temperature for both higher (2.6THz) and lower (0.3-0.6THz) LO frequencies could be interesting in order to understand the nature of the THz response of MgB₂ HEBs, as well as the gain bandwidth measurement with mixing of two monochromatic sources. Of great interest are HEBs with a high T_c [23]. Reduction of the electron-phonon interaction time due to the high T_c leads to an increase of the IF bandwidth. The problem of higher LO power requirements could be solved by fabrication of smaller HEBs and increase of the bath temperature [18,22].

ACKNOWLEDGMENT

The research was carried out at Terahertz and Millimetre Wave Laboratory, Chalmers University of Technology with financial support of European Research Council (ERC) under the grant Teramix.

REFERENCES

- [1] P. H. Siegel, "Terahertz technology," *IEEE Trans. Microwave Theory and Tech.*, vol. 50, no. 3, pp. 910–928, Mar. 2002.
- [2] G.J. Stacey, "THz low resolution spectroscopy for astronomy", *IEEE Trans. Terahertz Sci. Technol.*, vol. 1, no. 1, pp. 241-255, Sept. 2011.
- [3] P. Ubertini et al., "Future of Space Astronomy: A global Road Map for the next decades," *Adv. in Space Res.*, vol. 50, no. 1, pp. 1–55, Jul. 2012.
- [4] E. F. Lauria et al., "First Astronomical Observations with an ALMA Band 6 (211-275 GHz) Sideband-Separating SIS Mixer-Preamp," *ALMA Memo* 553.
- [5] R. Gusten et al., "The Atacama Pathfinder Experiment (APEX) - A new submillimeter facility for southern skies", *Astronomy & Astrophysics*, vol. 454, no. 2, pp. L13-L16, Aug. 2006.
- [6] T. de Graauw et al., "The Herschel-Heterodyne Instrument for the Far-Infrared (HIFI)," *Astronomy & Astrophysics*, vol. 518, pp. L6, Jul. 2010.
- [7] A. Krabbe et al., "SOFIA, an airborne observatory for infrared astronomy", *European Jour. of Phys.*, vol. 34, no. 6, pp. S161-S177, Nov. 2013.
- [8] E. Schlecht et al., "Schottky diode based 1.2 THz receivers operating at room-temperature and below for planetary atmospheric sounding", *IEEE Trans. Terahertz Sci. Technol.*, vol. 4, no. 6, pp. 661-669, Nov. 2014.
- [9] K.H. Gundlach, M. Schicke, "SIS and bolometer mixers for terahertz frequencies", *Supercond. Sci. Technol.*, vol. 13, no. 12, pp. R171-R187, Dec. 2000.
- [10] E.M. Gershenzon et al., "Heating of electrons in superconductor in the resistive state due to electromagnetic radiation", *Solid State Communications*, vol. 50, no. 3, pp. 207-212, Apr. 1984.
- [11] E.M. Gershenzon, G.N. Gol'tsman, "Hot Electron Superconductive Mixers," 4th International Symposium on Space Terahertz Technology 1993, ISSTT 1993, pp. 618-622.
- [12] S. Cherednichenko, V. Drakinskiy, T. Berg, P. Khosropanah, and E. Kollberg, "Hot-electron bolometer terahertz mixers for the Herschel Space Observatory," *Review of Scientific Instruments*, vol. 79, no. 3, pp. 034501-10, Mar. 2008.
- [13] J. Nagamatsu et al., "Superconductivity at 39 K in magnesium diboride," *Nature*, vol. 410, no. 6824, pp. 63–64, Feb 2001.
- [14] H. Shibata, T. Akazaki and Y. Tokura, "Ultrathin MgB₂ films fabricated by molecular beam epitaxy and rapid annealing", *Supercond. Sci. Technol.*, vol. 26, no. 3, Mar. 2013.
- [15] Y. Zhang et al., "Ultrathin MgB₂ films fabricated on Al₂O₃ substrate by hybrid physical-chemical vapor deposition with high T_c and J_c ", *Superconductor Science and Technology*, vol. 24, no. 1, 2011.
- [16] S. Bevilacqua, S. Cherednichenko, V. Drakinskiy, J. Stake, H. Shibata and Y. Tokura, "Low noise MgB₂ terahertz hot-electron bolometer mixers," *Appl. Phys. Lett.*, vol. 100, no. 3, p. 033504, Jan. 2012.
- [17] S. Bevilacqua, S.Cherednichenko, V. Drakinskiy, J. Stake, H. Shibata and Y.Tokura, "Study of IF Bandwidth of MgB Phono-Cooled Hot-Electron Bolometer Mixers ", *IEEE Trans. Terahertz Sci. Technol.* vol. 3, no. 4, pp. 409-415, Jul. 2013
- [18] D. Cunnane, J. Kawamura, B.S. Karasik, M.A. Wolak, X. X. Xi, "Development of hot-electron THz bolometric mixers using MgB₂ thin films", *Proc. of SPIE*, vol. 9153, 91531Q-1, Jul. 2014.
- [19] S. Bevilacqua, E. Novoselov, S. Cherednichenko, "MgB₂ Hot-Electron Bolometer Mixers at Terahertz Frequencies," *IEEE Trans. Appl. Supercond.*, Oct. 2014 (preprint).
- [20] H.Y. Zhai, H.M. Christen, L. Zhang, M. Paranthaman, P.H. Fleming and D.H. Lowndes, "Degradation of superconducting properties in MgB₂ films by exposure to water", *Supercond. Sci. Tech.*, vol. 14, no. 7, pp. 425-428, Jul. 2001.
- [21] G.N. Gol'tsman et al., "NbN hot electron superconducting mixers for 100 GHz operation," *IEEE Trans. Appl. Supercond.*, vol. 5, pp. 3065-3068, Jun. 1995.
- [22] D. Cunnane, J.H. Kawamura, M.A. Wolak, N. Acharya, T. Tan, X.X. Xi and B.S. Karasik, "Characterization of MgB₂ Superconducting Hot Electron Bolometers," *IEEE Trans. Appl. Supercond.*, vol. 25, no. 3, Jun. 2015.
- [23] B.S. Karasik, "Optimal choice of material for heb superconducting mixers", *IEEE Trans. Appl. Supercond.*, vol. 9, no. 2, pp. 4213-4216, Jun. 1999.