

Polarization in Interferometry

Steven T. Myers
(NRAO-Socorro)

*Twelfth Synthesis Imaging Workshop
Socorro, June 8-15, 2010*



Polarization in interferometry

- Astrophysics of Polarization
- Physics of Polarization
- Antenna Response to Polarization
- Interferometer Response to Polarization
- Polarization Calibration & Observational Strategies
- Polarization Data & Image Analysis

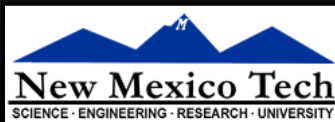

S.T. Myers – Twelfth Synthesis Imaging Workshop, June 8, 2010



DON'T PANIC!

- There are lots of equations and concepts. Hang in there.
- I will illustrate the concepts with figures and 'handwaving'.
- Many good references:
 - Synthesis Imaging II: Lecture 6, also parts of 1, 3, 5, 32
 - Born and Wolf: Principle of Optics, Chapters 1 and 10
 - Rolfes and Wilson: Tools of Radio Astronomy, Chapter 2
 - Thompson, Moran and Swenson: Interferometry and Synthesis in Radio Astronomy, Chapter 4
 - Tinbergen: Astronomical Polarimetry. All Chapters.
 - J.P. Hamaker et al., A&A, 117, 137 (1996) and series of papers
- Great care must be taken in studying these references – conventions vary between them.

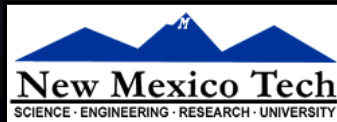

S.T. Myers – Twelfth Synthesis Imaging Workshop, June 8, 2010



Polarization Astrophysics

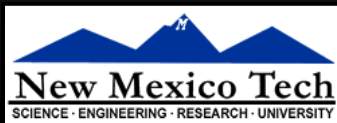

S.T. Myers – Twelfth Synthesis Imaging Workshop, June 8, 2010



Why Measure Polarization?

- Electromagnetic waves are intrinsically polarized
 - monochromatic waves are fully polarized
- Polarization state of radiation can tell us about:
 - the origin of the radiation
 - intrinsic polarization, orientation of generating B-field
 - the medium through which it traverses
 - propagation and scattering effects
 - unfortunately, also about the purity of our optics
 - you may be forced to observe polarization even if you do not want to!

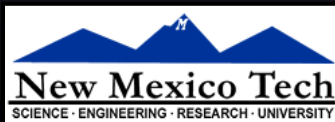

S.T. Myers – Twelfth Synthesis Imaging Workshop, June 8, 2010



Astrophysical Polarization

- Examples:
 - Processes which generate polarized radiation:
 - Synchrotron emission: Up to ~80% linearly polarized, with no circular polarization. Measurement provides information on strength and orientation of magnetic fields, level of turbulence.
 - Zeeman line splitting: Presence of B-field splits RCP and LCP components of spectral lines (2.8 Hz/ μ G for HI). Measurement provides direct measure of B-field.
 - Processes which modify polarization state:
 - Free electron scattering: Induces a linear polarization which can indicate the origin of the scattered radiation.
 - Faraday rotation: Magnetoionic region rotates plane of linear polarization. Measurement of rotation gives B-field estimate.
 - Faraday conversion: Particles in magnetic fields can cause the polarization ellipticity to change, turning a fraction of the linear polarization into circular (possibly seen in cores of AGN)

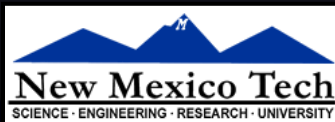

S.T. Myers – Twelfth Synthesis Imaging Workshop, June 8, 2010



Example: Radio Galaxy Cygnus A

- VLA @ 8.5 GHz B-vectors Perley & Carilli (1996)

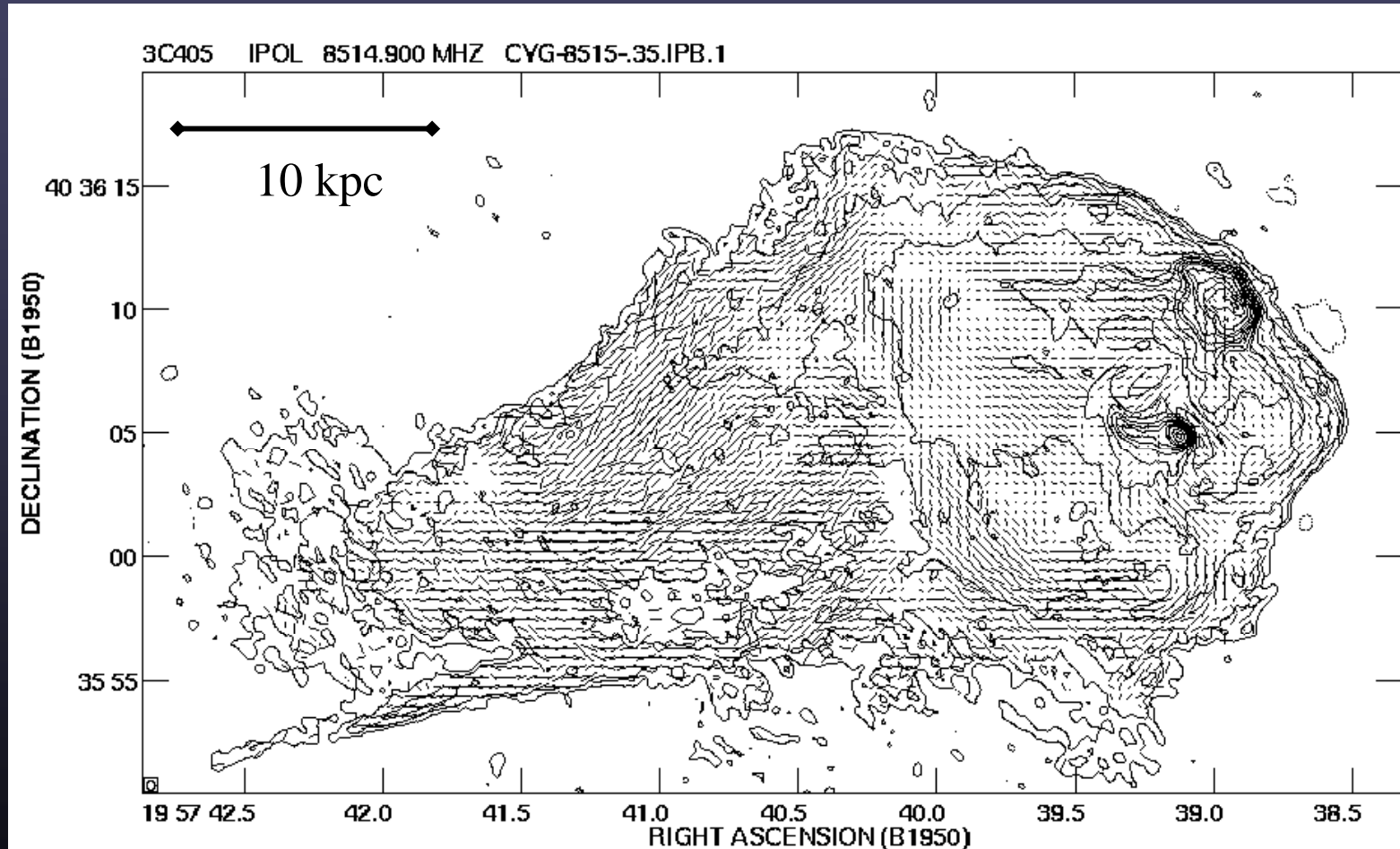

Example: Faraday rotation of CygA

- See review of “Cluster Magnetic Fields” by Carilli & Taylor 2002 (ARAA)

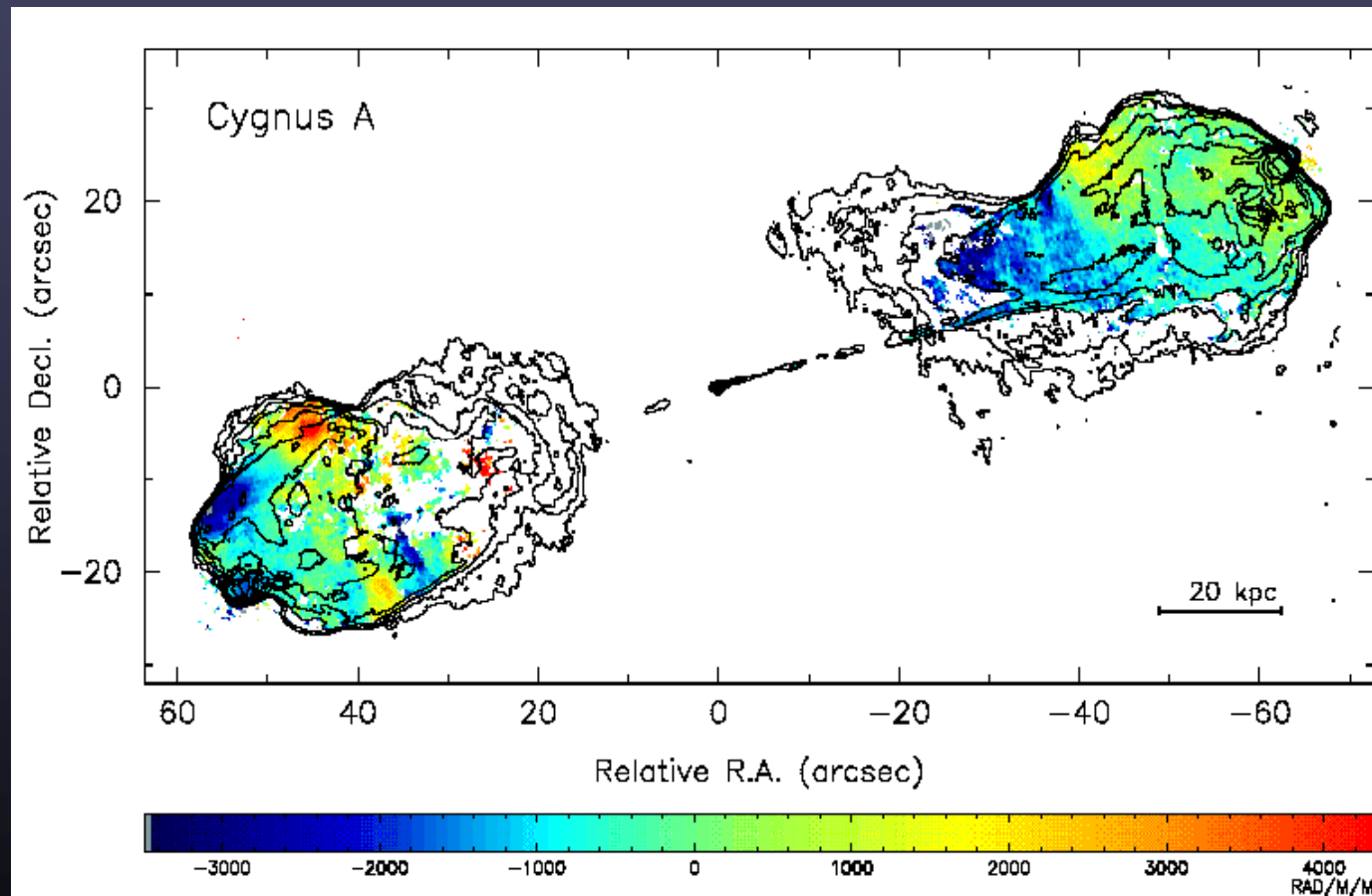

Example: Zeeman effect

Zeeman Effect

Atoms and molecules with a net magnetic moment will have their energy levels split in the presence of a magnetic field.

⇒ HI, OH, CN, H₂O

⇒ Detected by observing the frequency shift between right and left circularly polarized emission

⇒ $V = \text{RCP} - \text{LCP} \propto B_{\text{los}}$

Spectral line profiles

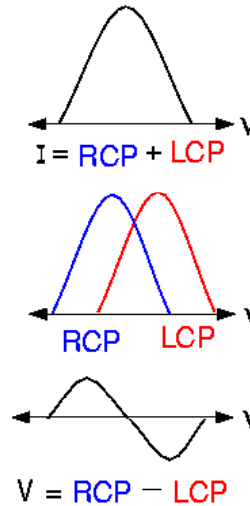

Energy Levels for HI Ground State

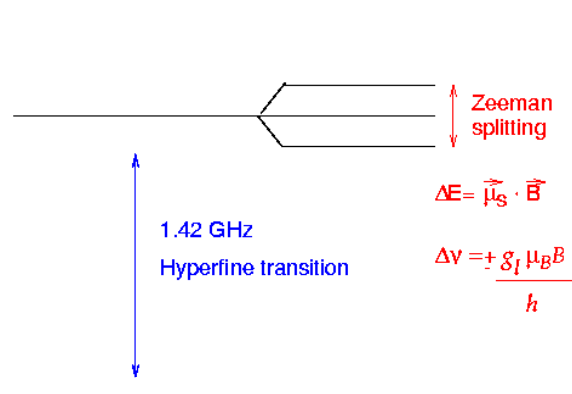

- \vec{B} $\vec{\mu}_s$
- \otimes \otimes Right Circular Polarization
- \otimes \rightarrow Linear Polarization
- \otimes \odot Left Circular polarization

W51C (2-b) $B_{\theta} = 2.5 \pm 0.2$ mG

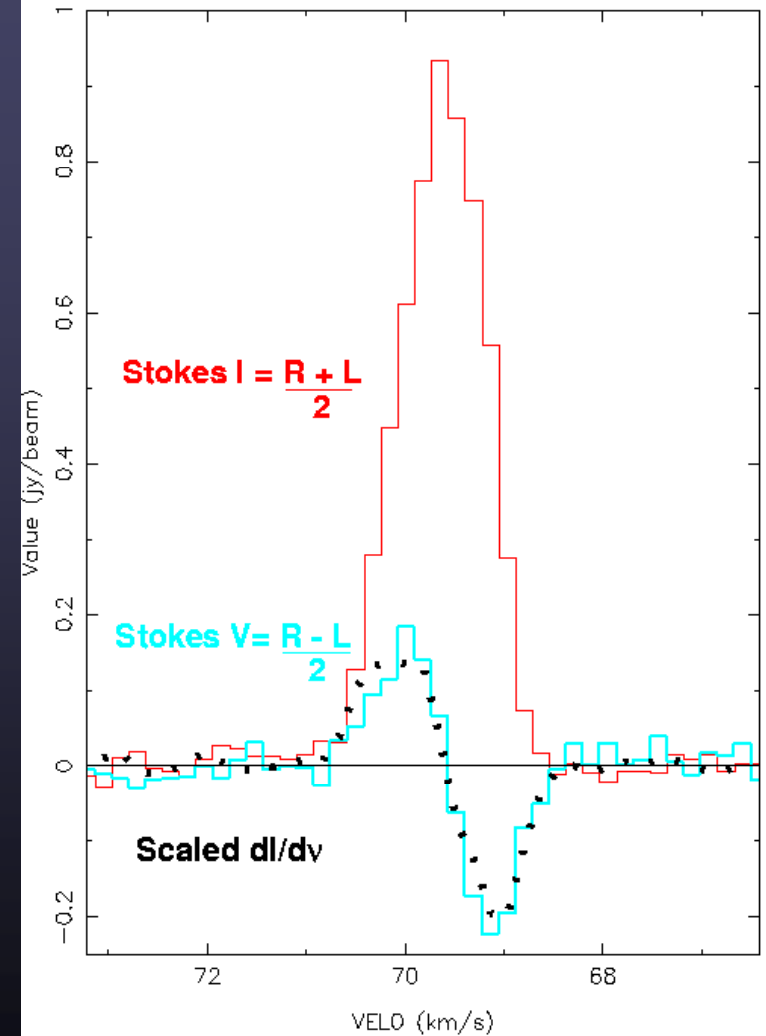

Example: the ISM of M51

- Trace magnetic field structure in galaxies
 - follow spiral structure
 - origin?
 - amplified in dynamo?

Neininger (1992)

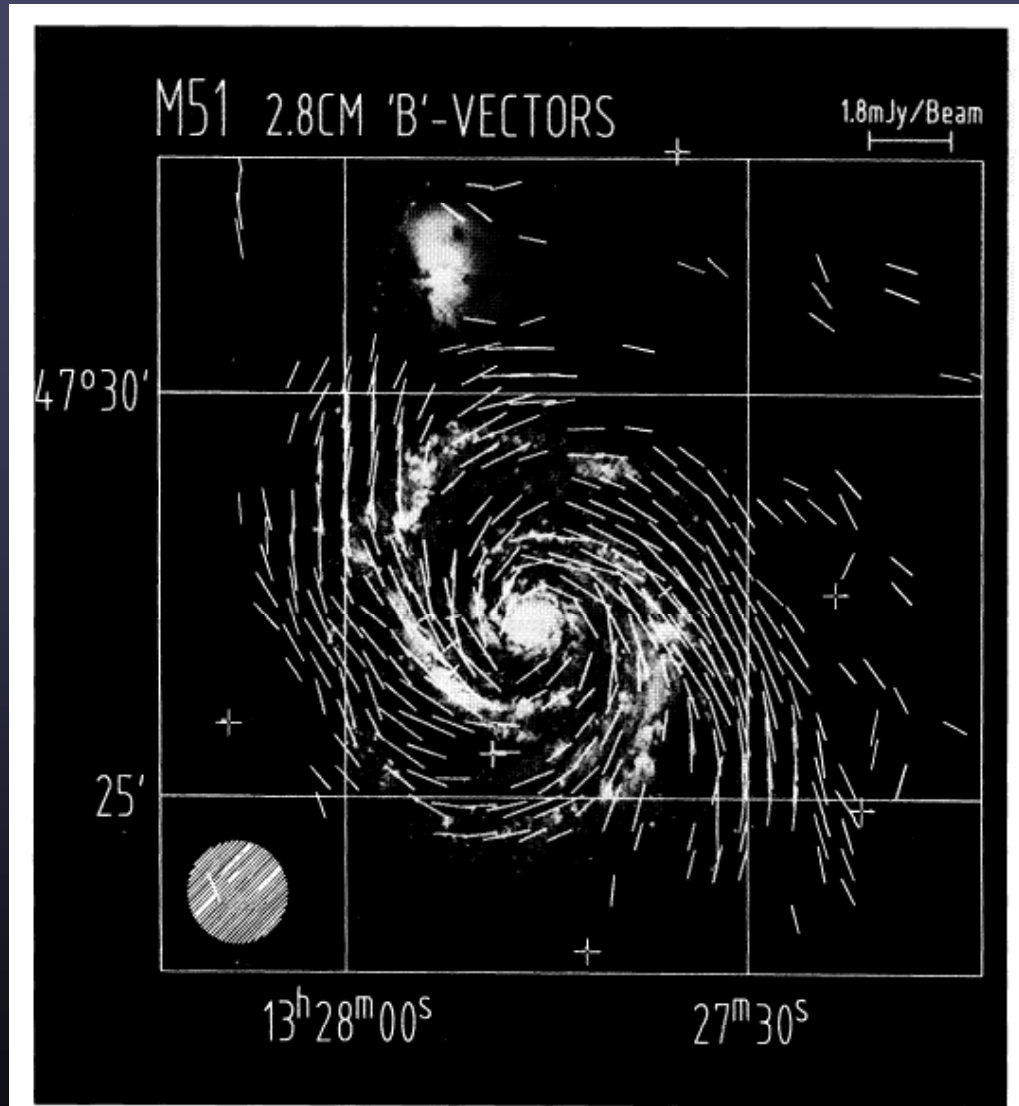

Scattering

- Anisotropic Scattering induces Linear Polarization
 - electron scattering (e.g. in Cosmic Microwave Background)
 - dust scattering (e.g. in the millimeter-wave spectrum)

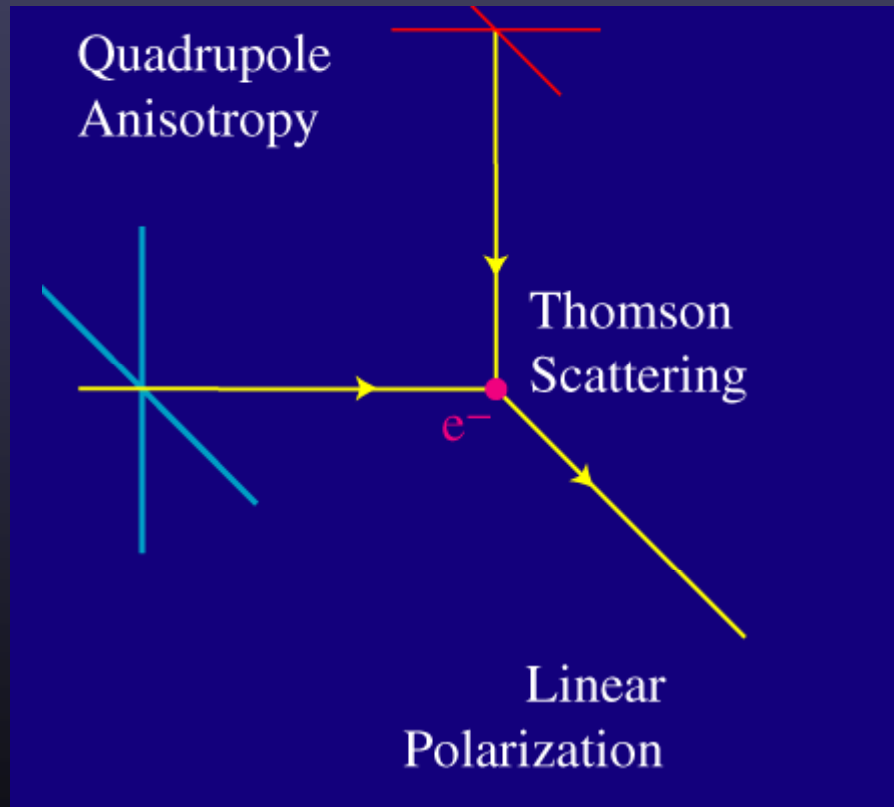

Planck predictions – Hu & Dodelson *ARAA* 2002

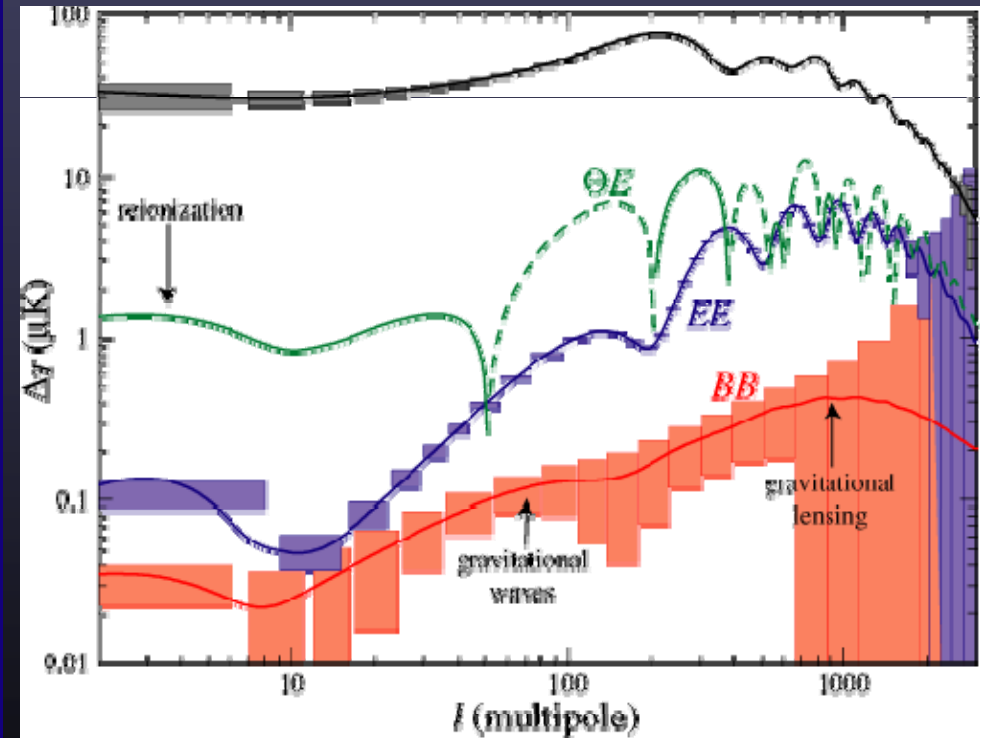

Polarization Fundamentals

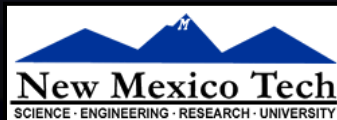

S.T. Myers – Twelfth Synthesis Imaging Workshop, June 8, 2010



The Polarization Ellipse

- From Maxwell's equations $\mathbf{E} \cdot \mathbf{B} = 0$ (\mathbf{E} and \mathbf{B} perpendicular)
 - By convention, we consider the time behavior of the \mathbf{E} -field in a fixed perpendicular plane, from the point of view of the receiver.

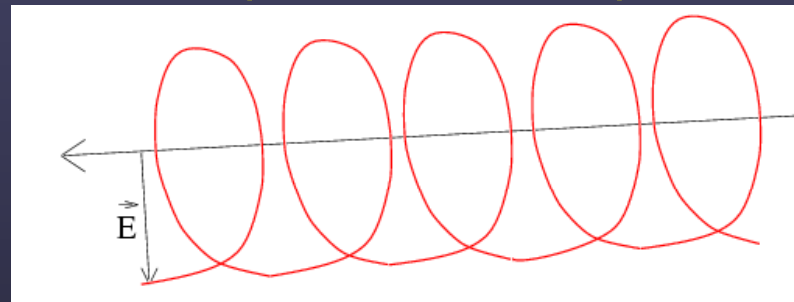

$$\mathbf{k} \cdot \mathbf{E} = 0$$

transverse wave

- For a monochromatic wave of frequency ν , we write

$$E_x = A_x \cos(2\pi\nu t + \phi_x)$$

$$E_y = A_y \cos(2\pi\nu t + \phi_y)$$

- These two equations describe an ellipse in the (x - y) plane.
- The ellipse is described fully by three parameters:
 - A_x , A_y , and the phase difference, $\delta = \phi_y - \phi_x$.

Elliptically Polarized Monochromatic Wave

The simplest description of wave polarization is in a Cartesian coordinate frame.

In general, three parameters are needed to describe the ellipse.

If the E-vector is rotating:

- clockwise, wave is 'Left Elliptically Polarized',
- counterclockwise, is 'Right Elliptically Polarized'.

The angle $\alpha = \text{atan}(A_y/A_x)$ is used later ...

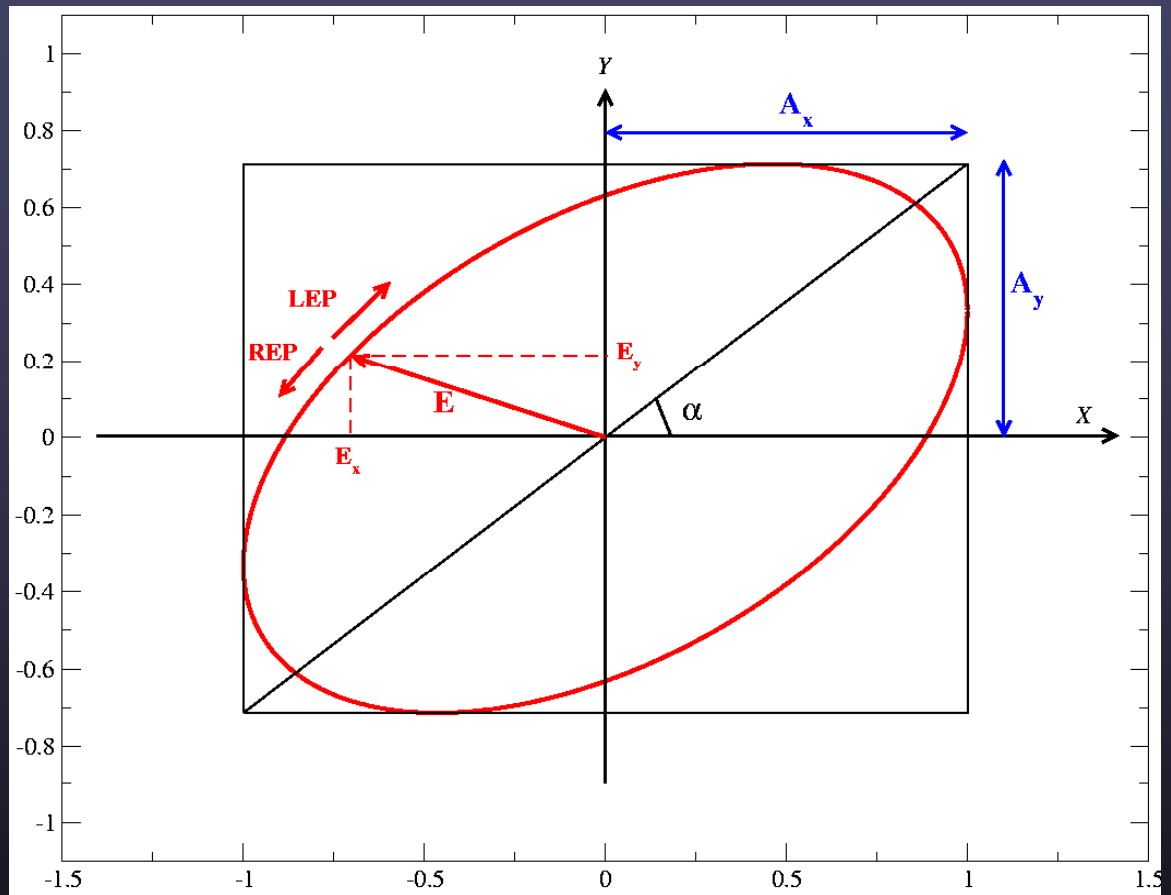

equivalent to 2 independent E_x and E_y oscillators

Polarization Ellipse Ellipticity and P.A.

- A more natural description is in a frame (ξ, η) , rotated so the ξ -axis lies along the major axis of the ellipse.
- The three parameters of the ellipse are then:

A_η : the major axis length

$\tan \chi = A_\xi / A_\eta$: the axial ratio

Ψ : the major axis p.a.

$$\tan 2\Psi = \tan 2\alpha \cos \delta$$

$$\sin 2\chi = \sin 2\alpha \sin \delta$$

- The ellipticity χ is signed:

$\chi > 0 \rightarrow \text{REP}$

$\chi < 0 \rightarrow \text{LEP}$

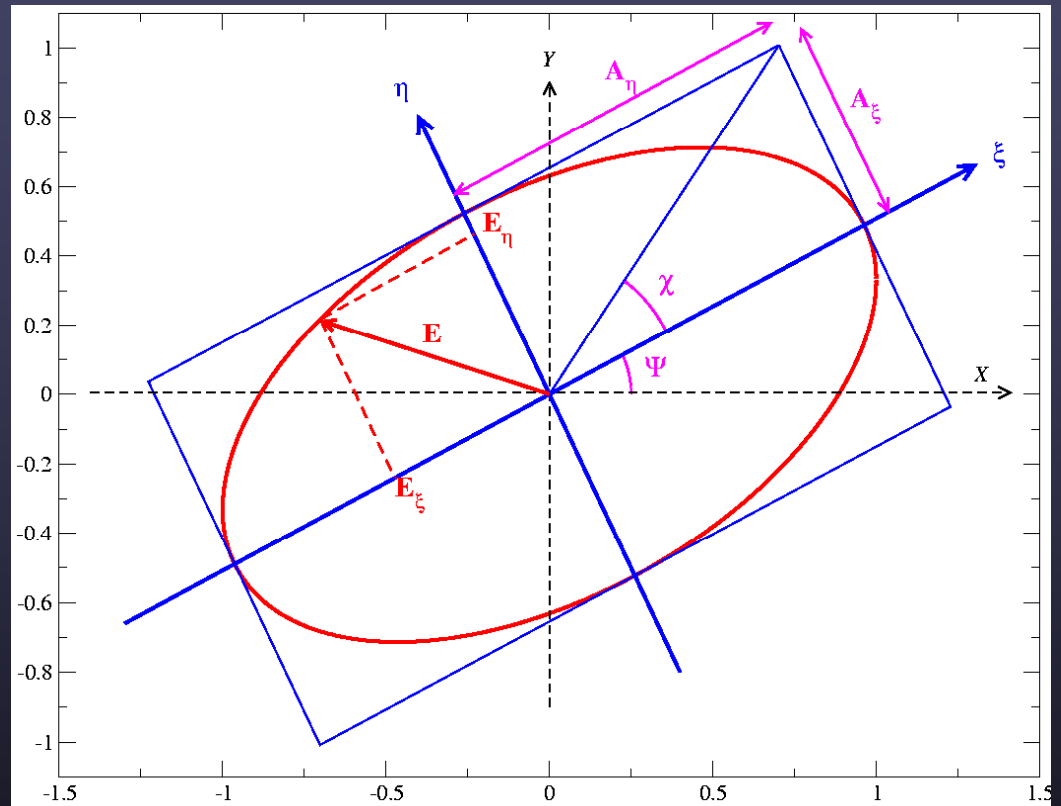

$\chi = 0, 90^\circ \rightarrow \text{Linear } (\delta=0^\circ, 180^\circ)$

$\chi = \pm 45^\circ \rightarrow \text{Circular } (\delta=\pm 90^\circ)$

Circular Basis

- We can decompose the E-field into a circular basis, rather than a (linear) Cartesian one:

$$\mathbf{E} = A_R \hat{e}_R + A_L \hat{e}_L$$

- where A_R and A_L are the amplitudes of two counter-rotating unit vectors, e_R (rotating counter-clockwise), and e_L (clockwise)
 - NOTE: R,L are obtained from X,Y by $\delta=\pm 90^\circ$ phase shift
- It is straightforward to show that:

$$A_R = \frac{1}{2} \sqrt{A_X^2 + A_Y^2 - 2 A_X A_Y \sin \delta_{XY}}$$

$$A_L = \frac{1}{2} \sqrt{A_X^2 + A_Y^2 + 2 A_X A_Y \sin \delta_{XY}}$$

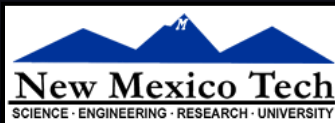

Circular Basis Example

- The black ellipse can be decomposed into an x-component of amplitude 2, and a y-component of amplitude 1 which lags by $\frac{1}{4}$ turn.
- It can alternatively be decomposed into a counterclockwise rotating vector of length 1.5 (red), and a clockwise rotating vector of length 0.5 (blue).

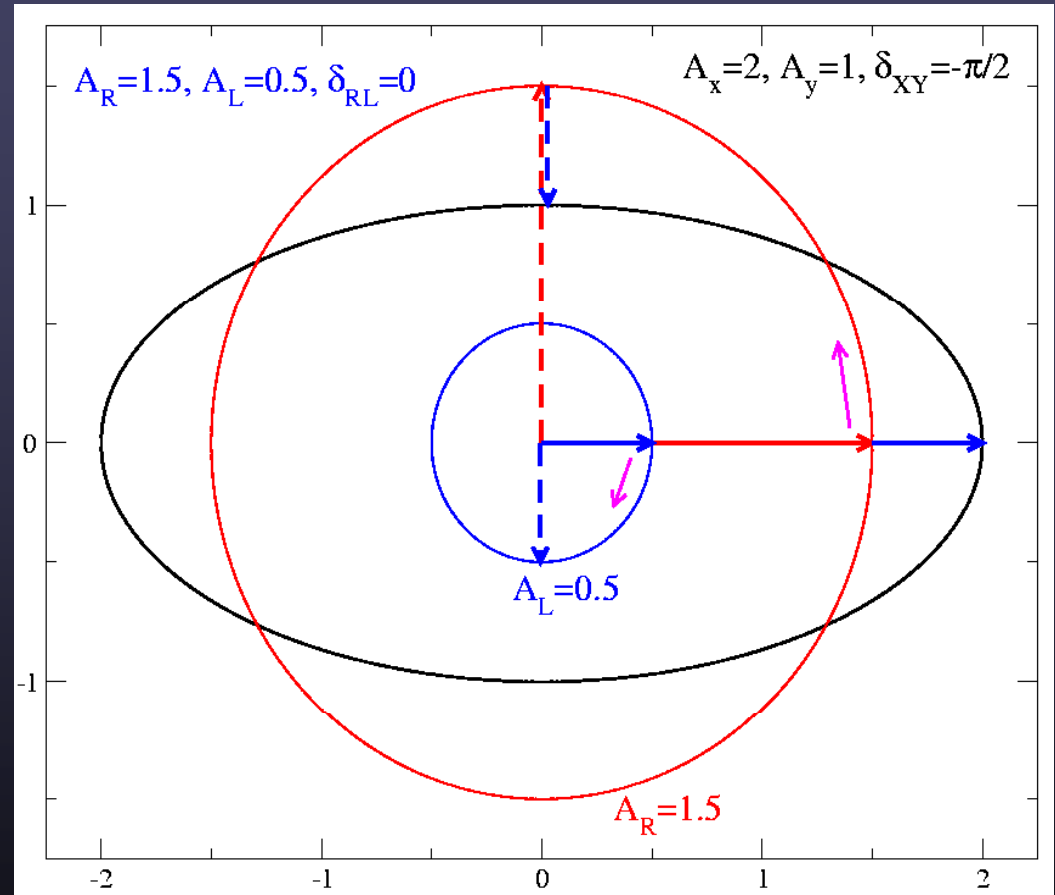

The Poincare Sphere

- Treat 2ψ and 2χ as longitude and latitude on sphere of radius $A=E^2$

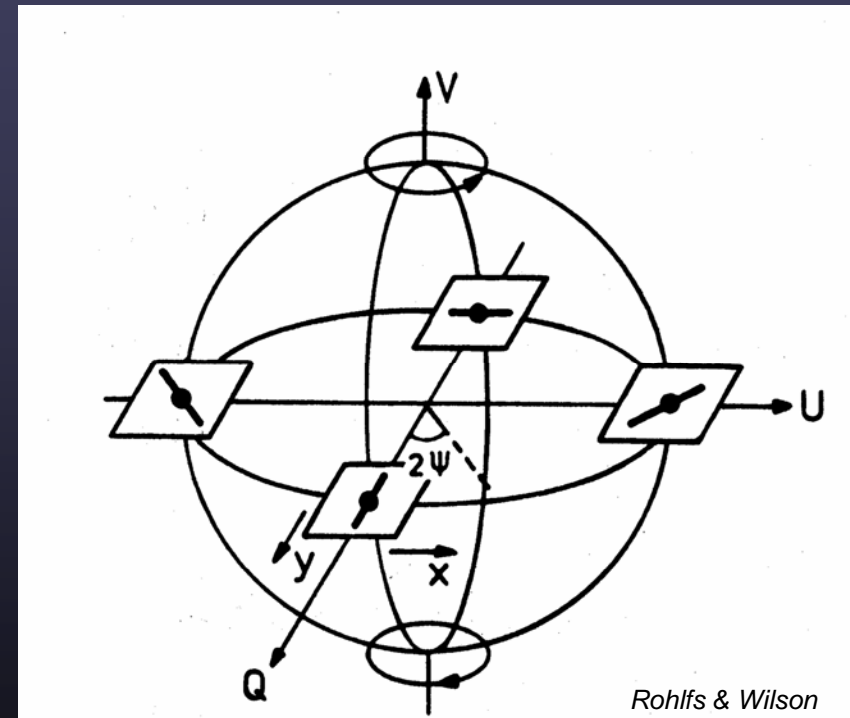
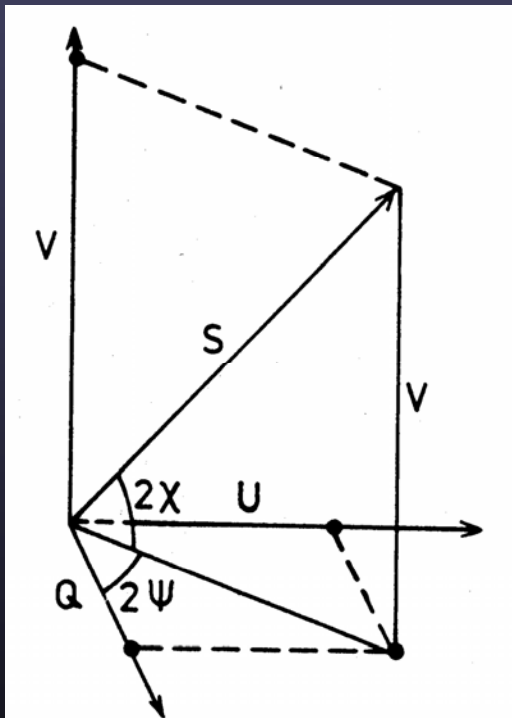

Stokes parameters

- Spherical coordinates: radius I , axes Q, U, V
 - $I = \sqrt{E_X^2 + E_Y^2} = \sqrt{E_R^2 + E_L^2}$
 - $Q = I \cos 2\chi \cos 2\psi = E_X^2 - E_Y^2 = 2 E_R E_L \cos \delta_{RL}$
 - $U = I \cos 2\chi \sin 2\psi = 2 E_X E_Y \cos \delta_{XY} = 2 E_R E_L \sin \delta_{RL}$
 - $V = I \sin 2\chi = 2 E_X E_Y \sin \delta_{XY} = E_R^2 - E_L^2$
- Only 3 independent parameters:
 - wave polarization confined to surface of Poincare sphere
 - $I^2 = Q^2 + U^2 + V^2$
- Stokes parameters I, Q, U, V
 - defined by George Stokes (1852)
 - form complete description of wave polarization
 - NOTE: above true for 100% polarized monochromatic wave!

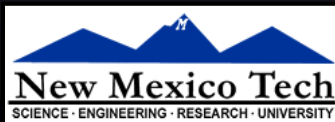

Linear Polarization

- Linearly Polarized Radiation: $V = 0$

- Linearly polarized flux:

$$P = \sqrt{Q^2 + U^2}$$

- Q and U define the linear polarization position angle:

$$\tan 2\psi = U / Q$$

- Signs of Q and U:

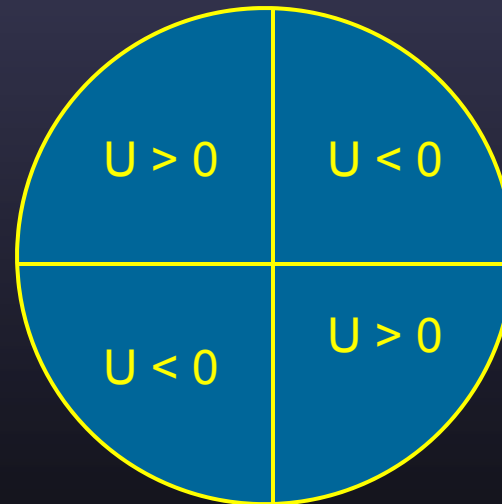
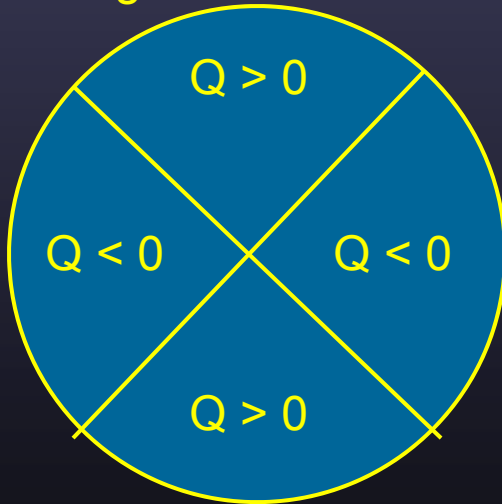

Simple Examples

- If $V = 0$, the wave is linearly polarized. Then,
 - If $U = 0$, and Q positive, then the wave is vertically polarized, $\Psi = 0^\circ$

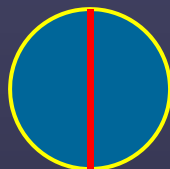

- If $U = 0$, and Q negative, the wave is horizontally polarized, $\Psi = 90^\circ$

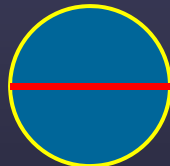

- If $Q = 0$, and U positive, the wave is polarized at $\Psi = 45^\circ$



- If $Q = 0$, and U negative, the wave is polarized at $\Psi = -45^\circ$.



Illustrative Example: Non-thermal Emission from Jupiter

- Apr 1999 VLA 5 GHz data
- D-config resolution is $14''$
- Jupiter emits thermal radiation from atmosphere, plus polarized synchrotron radiation from particles in its magnetic field
- Shown is the I image (intensity) with polarization vectors rotated by 90° (to show B-vectors) and polarized intensity (blue contours)
- The polarization vectors trace Jupiter's dipole
- Polarized intensity linked to the Io plasma torus

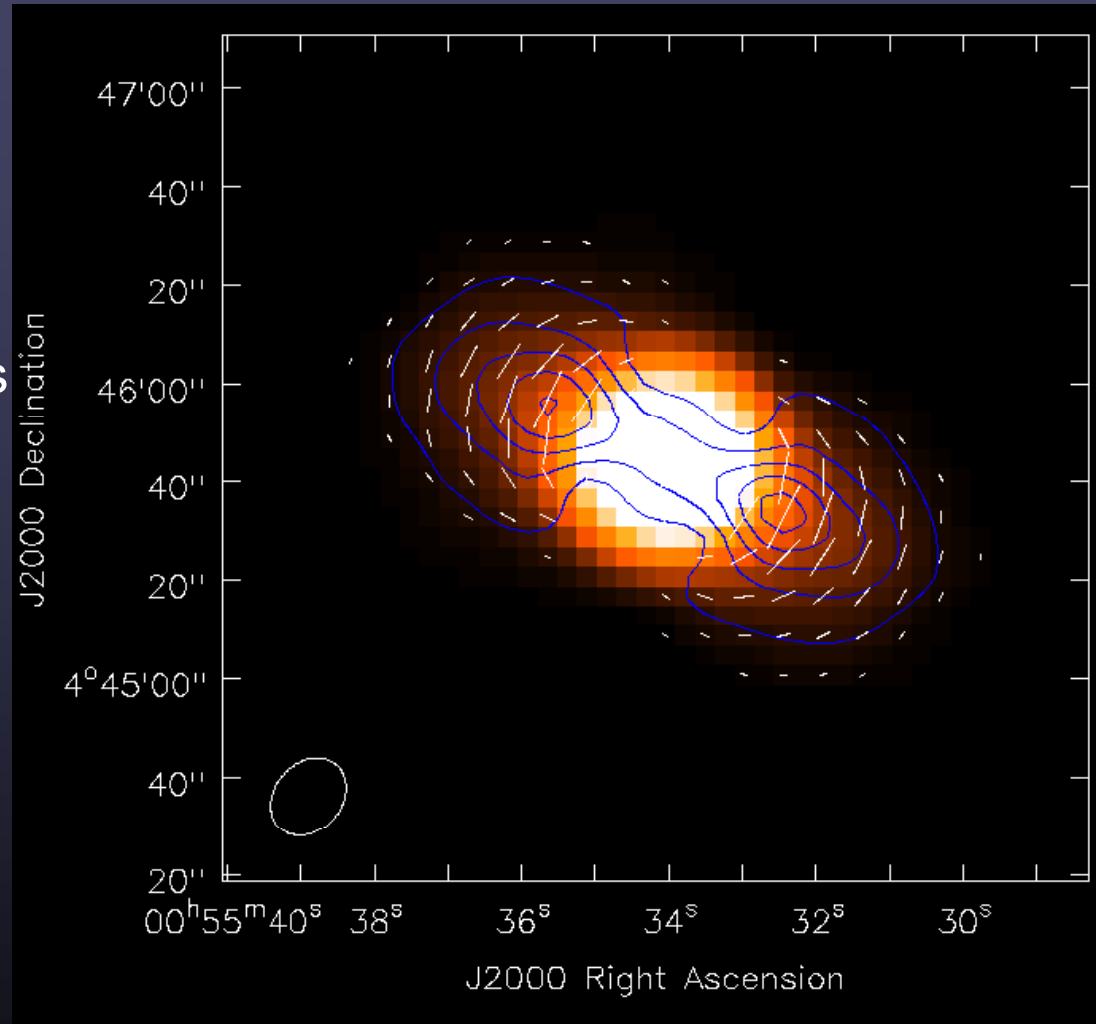

Why Use Stokes Parameters?

- Tradition
- They are scalar quantities, independent of basis XY, RL
- They have units of power (flux density when calibrated)
- They are simply related to actual antenna measurements.
- They easily accommodate the notion of partial polarization of non-monochromatic signals.
- We can (as I will show) make images of the I, Q, U, and V intensities directly from measurements made from an interferometer.
- These I,Q,U, and V images can then be combined to make images of the linear, circular, or elliptical characteristics of the radiation.

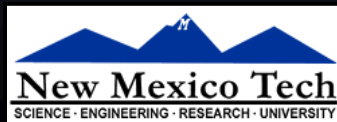

S.T. Myers – Twelfth Synthesis Imaging Workshop, June 8, 2010



Partial Polarization

- Monochromatic radiation is a myth.
- No such entity can exist (although it can be closely approximated).
- In real life, radiation has a finite bandwidth.
- Real astronomical emission processes arise from randomly placed, independently oscillating emitters (electrons).
- We observe the summed electric field, using instruments of finite bandwidth.
- Despite the chaos, polarization still exists, but is not complete – partial polarization is the rule.

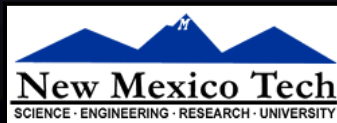

S.T. Myers – Twelfth Synthesis Imaging Workshop, June 8, 2010



Stokes Parameters for Partial Polarization

Stokes parameters defined in terms of mean quantities:

$$I = \langle E_x^2 \rangle + \langle E_y^2 \rangle = \langle E_r^2 \rangle + \langle E_l^2 \rangle$$

$$Q = \langle E_x^2 \rangle - \langle E_y^2 \rangle = 2\langle E_r E_l \cos \delta_{rl} \rangle$$

$$U = 2\langle E_x E_y \cos \delta_{xy} \rangle = 2\langle E_r E_l \sin \delta_{rl} \rangle$$

$$V = 2\langle E_x E_y \sin \delta_{xy} \rangle = \langle E_r^2 \rangle - \langle E_l^2 \rangle$$

Note that now, unlike monochromatic radiation, the radiation is not necessarily 100% polarized.

$$I^2 \geq Q^2 + U^2 + V^2$$

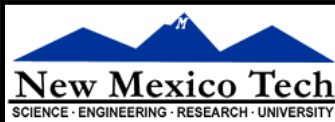

S.T. Myers – Twelfth Synthesis Imaging Workshop, June 8, 2010



Summary – Fundamentals

- Monochromatic waves are polarized
- Expressible as 2 orthogonal independent transverse waves
 - elliptical cross-section → polarization ellipse
 - 3 independent parameters
 - choice of basis, e.g. linear or circular
- Poincare sphere convenient representation
 - Stokes parameters I, Q, U, V
 - I intensity; Q,U linear polarization, V circular polarization
- Quasi-monochromatic “waves” in reality
 - can be partially polarized
 - still represented by Stokes parameters

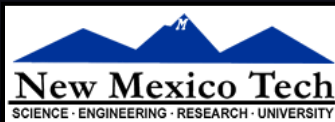

S.T. Myers – Twelfth Synthesis Imaging Workshop, June 8, 2010



Antenna Polarization

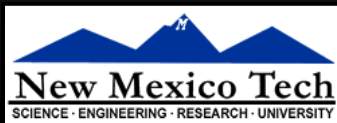

S.T. Myers – Twelfth Synthesis Imaging Workshop, June 8, 2010



Measuring Polarization on the sky

- Coordinate system dependence:

- I independent

- V depends on choice of “handedness”

- $V > 0$ for RCP

- Q,U depend on choice of “North” (plus handedness)

- Q “points” North, U 45 toward East

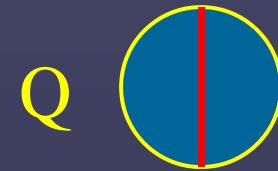

- Polarization Angle Ψ

$$\Psi = \frac{1}{2} \tan^{-1} (U/Q) \quad (\text{North through East})$$

- also called the “electric vector position angle” (EVPA)

- by convention, traces E-field vector (e.g. for synchrotron)

- B-vector is perpendicular to this

Optics – Cassegrain radio telescope

- Paraboloid illuminated by feedhorn:

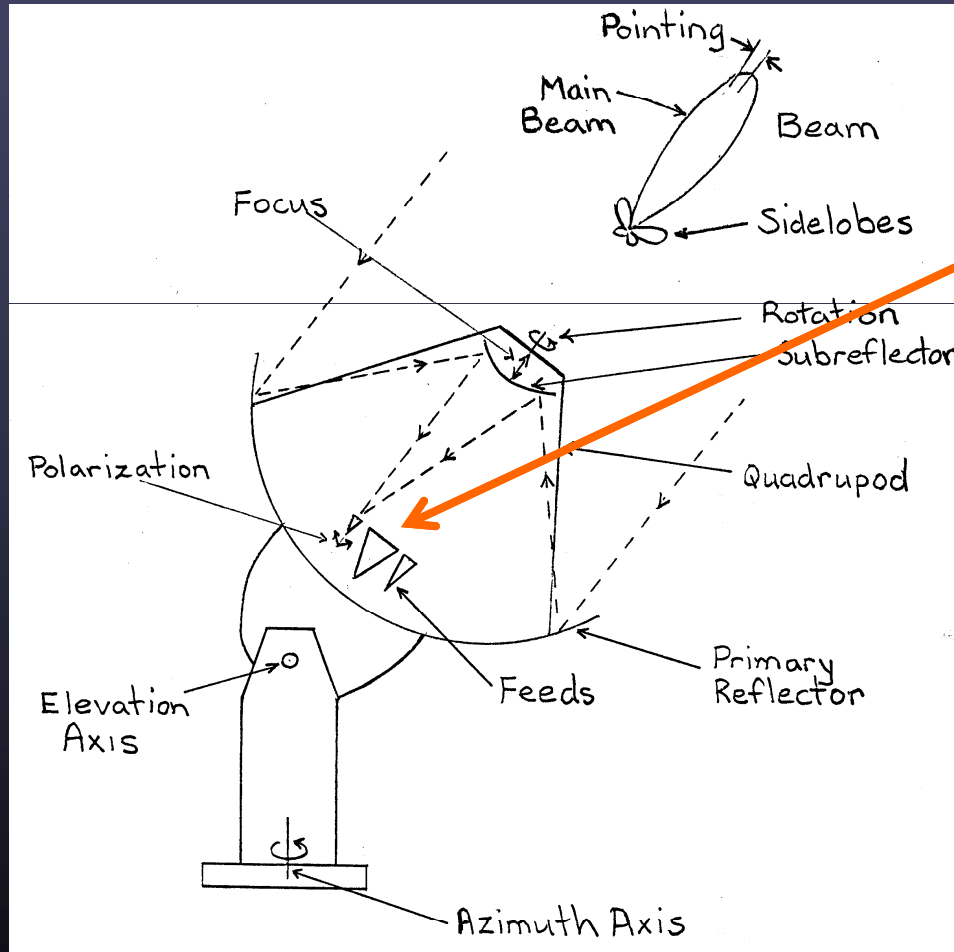

Feeds arranged in focal plane (off-axis)

Optics – telescope response

- Reflections
 - turn RCP \leftrightarrow LCP
 - E-field (currents) allowed only in plane of surface
- “Field distribution” on aperture for E and H planes:

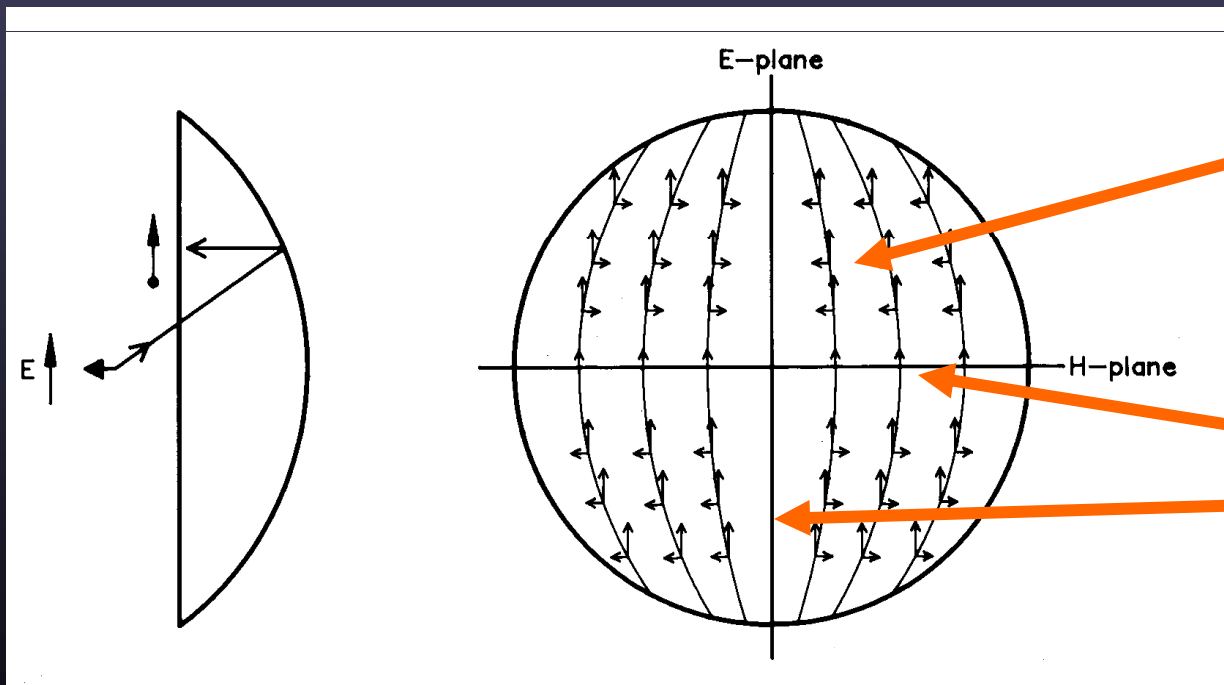

Cross-polarization
at 45°

No cross-polarization
on axes

Example – simulated VLA patterns

- EVLA Memo 58 “Using Grasp8 to Study the VLA Beam” W. Bricken

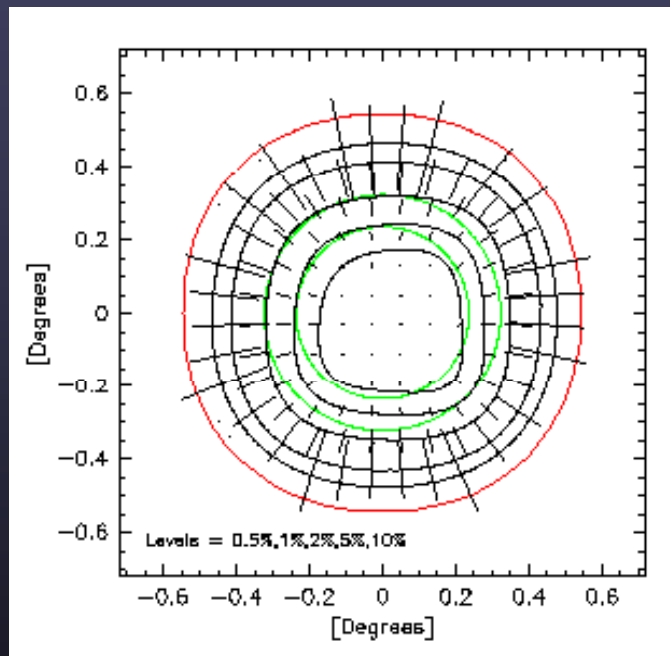

Linear Polarization

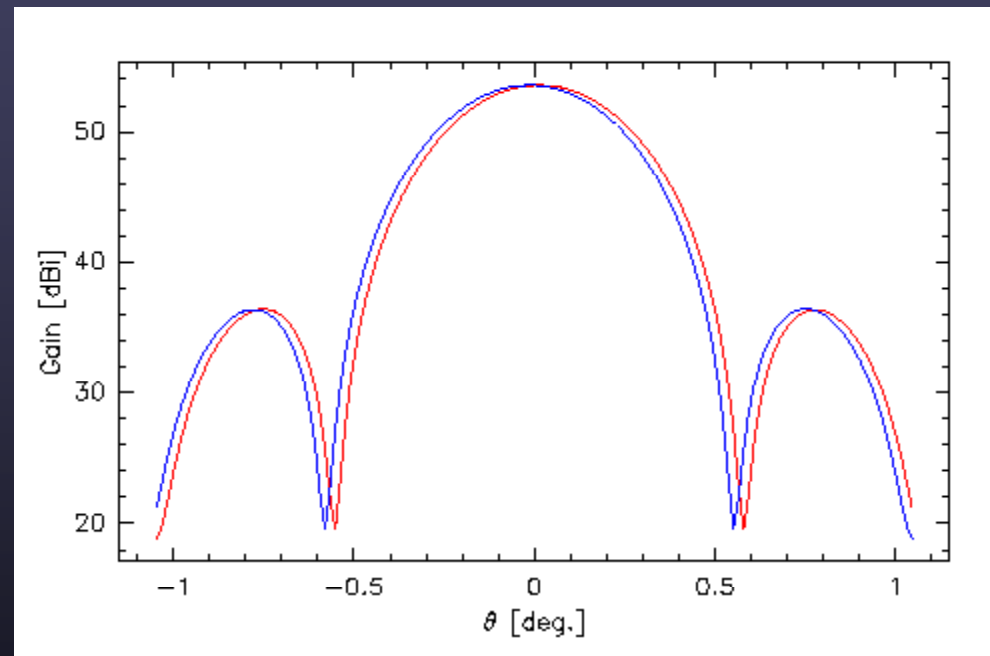

Circular Polarization cuts in R & L

Example – measured VLA patterns

- AIPS Memo 86 “Widefield Polarization Correction of VLA Snapshot Images at 1.4 GHz” W. Cotton (1994)

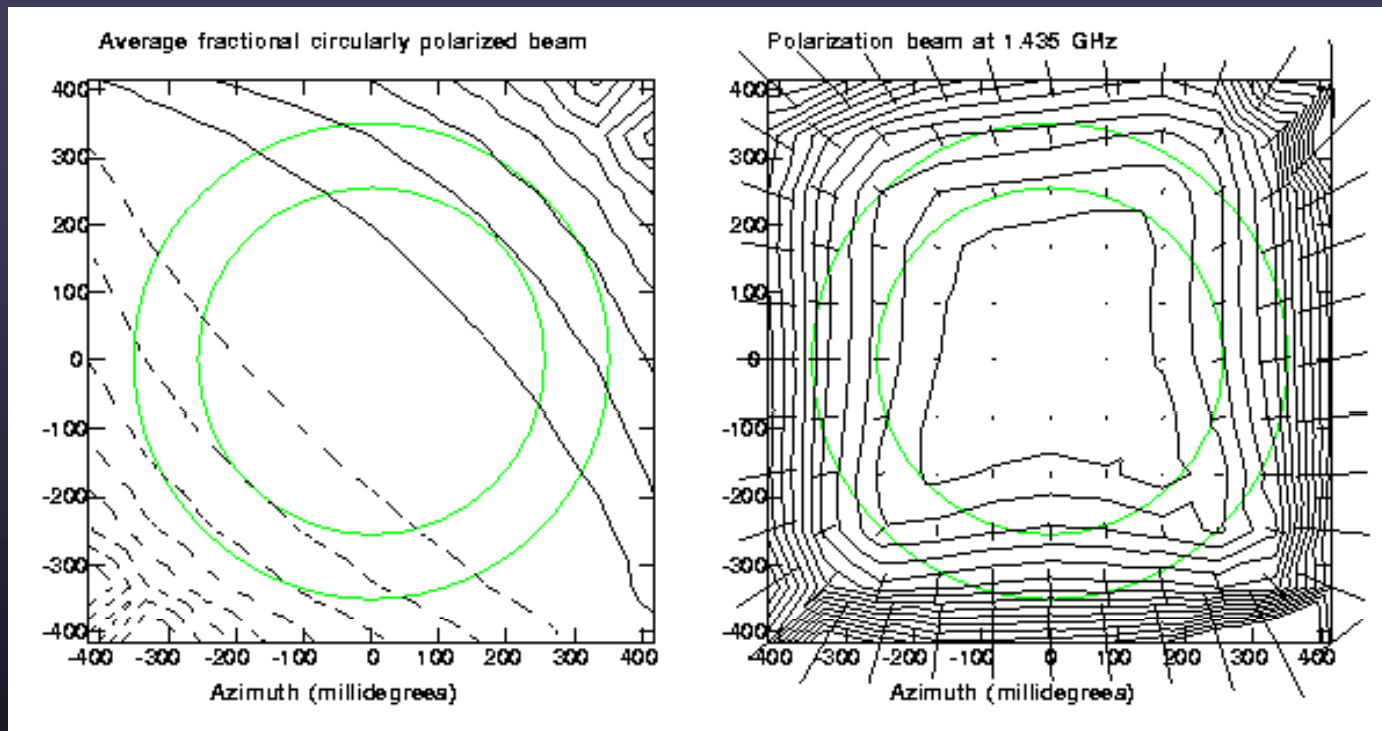

Circular Polarization

Linear Polarization

Polarization Receiver Outputs

- To do polarimetry (measure the polarization state of the EM wave), the antenna must have two outputs which respond differently to the incoming elliptically polarized wave.
- It would be most convenient if these two outputs are proportional to either:
 - The two linear orthogonal Cartesian components, (E_x, E_y) as in ATCA and ALMA
 - The two circular orthogonal components, (E_R, E_L) as in VLA
- Sadly, this is not the case in general.
 - In general, each port is elliptically polarized, with its own polarization ellipse, with its p.a. and ellipticity.
- However, as long as these are different, polarimetry can be done.

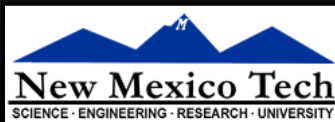

S.T. Myers – Twelfth Synthesis Imaging Workshop, June 8, 2010



Polarizers: Quadrature Hybrids

- We've discussed the two bases commonly used to describe polarization.
- It is quite easy to transform signals from one to the other, through a real device known as a 'quadrature hybrid'.

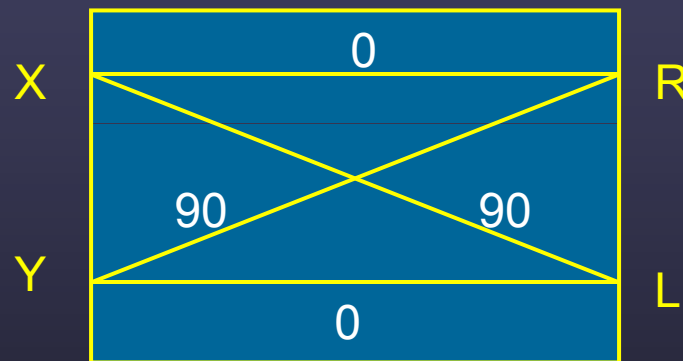

Four Port Device:
2 port input
2 ports output
mixing matrix

- To transform correctly, the phase shifts must be exactly 0 and 90 for all frequencies, and the amplitudes balanced.
- Real hybrids are imperfect – generate errors (mixing/leaking)
- Other polarizers (e.g. waveguide septum, grids) equivalent

Polarization Interferometry

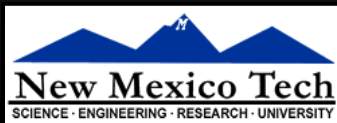

S.T. Myers – Twelfth Synthesis Imaging Workshop, June 8, 2010



Four Complex Correlations per Pair

- Two antennas, each with two differently polarized outputs, produce four complex correlations.
- From these four outputs, we want to make four Stokes Images.

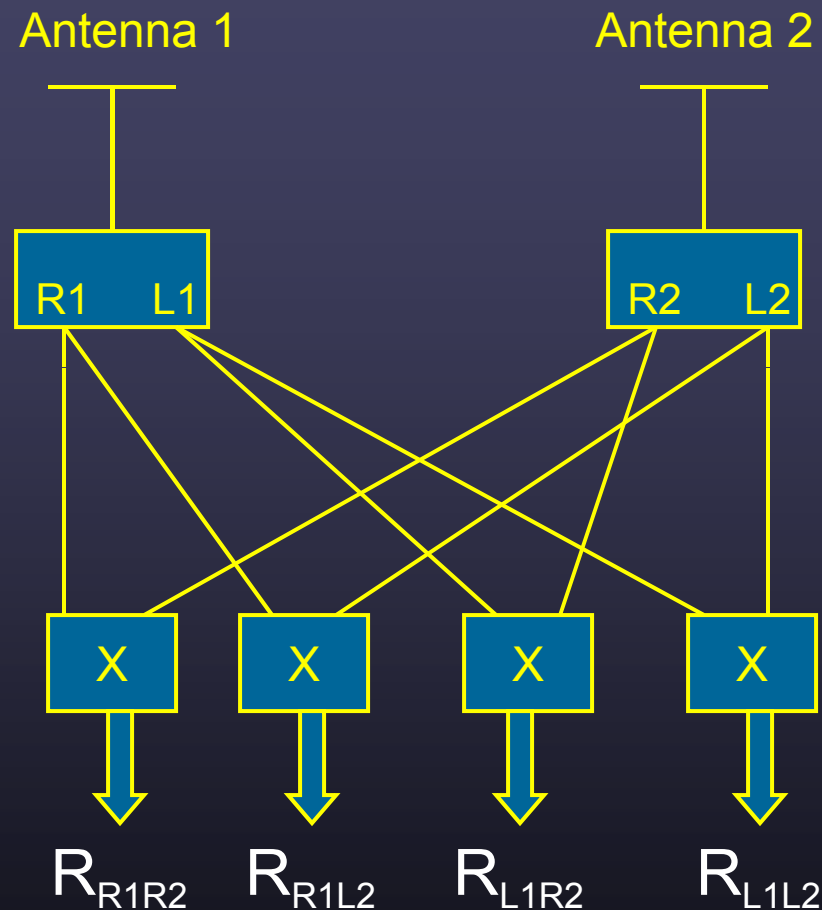

Outputs: Polarization Vectors

- Each telescope receiver has two outputs
 - should be orthogonal, close to X,Y or R,L
 - even if single pol output, convenient to consider both possible polarizations (e.g. for leakage)
 - put into vector

$$\vec{E}(t) = \begin{pmatrix} E_R(t) \\ E_L(t) \end{pmatrix} \quad \text{or} \quad \vec{E}(t) = \begin{pmatrix} E_X(t) \\ E_Y(t) \end{pmatrix}$$

Correlation products: coherency vector

- Coherency vector: outer product of 2 antenna vectors as averaged by correlator

$$\vec{v}_{ij} = \left\langle \vec{E}_i \otimes \vec{E}_j^* \right\rangle = \left\langle \begin{pmatrix} E^p \\ E^q \end{pmatrix}_i \otimes \begin{pmatrix} E^p \\ E^q \end{pmatrix}_j^* \right\rangle = \begin{pmatrix} \langle E_i^p \cdot E_j^{*p} \rangle \\ \langle E_i^p \cdot E_j^{*q} \rangle \\ \langle E_i^q \cdot E_j^{*p} \rangle \\ \langle E_i^q \cdot E_j^{*q} \rangle \end{pmatrix} = \begin{pmatrix} v^{pp} \\ v^{pq} \\ v^{qp} \\ v^{qq} \end{pmatrix}_{ij}$$

- these are essentially the uncalibrated *visibilities* \mathbf{v}
 - circular products RR, RL, LR, LL
 - linear products XX, XY, YX, YY
- need to include corrections before and after correlation

Polarization Products: General Case

$$v^{pq} = \frac{1}{2} G_{pq} \{ I [\cos(\Psi_p - \Psi_q) \cos(\chi_p - \chi_q) + i \sin(\Psi_p - \Psi_q) \sin(\chi_p + \chi_q)] \\ + Q [\cos(\Psi_p + \Psi_q) \cos(\chi_p + \chi_q) + i \sin(\Psi_p + \Psi_q) \sin(\chi_p - \chi_q)] \\ - i U [\cos(\Psi_p + \Psi_q) \sin(\chi_p - \chi_q) + i \sin(\Psi_p + \Psi_q) \cos(\chi_p + \chi_q)] \\ - V [\cos(\Psi_p - \Psi_q) \sin(\chi_p + \chi_q) + i \sin(\Psi_p - \Psi_q) \cos(\chi_p - \chi_q)] \}$$

What are all these symbols?

v^{pq} is the complex output from the interferometer, for polarizations p and q from antennas 1 and 2, respectively.

Ψ and χ are the antenna polarization major axis and ellipticity for states p and q.

I, Q, U, and V are the **Stokes Visibilities** describing the polarization state of the astronomical signal.

G is the gain, which falls out in calibration.

CONVENTION – WE WILL ABSORB FACTOR 1/2 INTO GAIN!!!!!!!

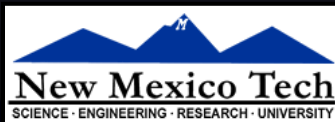

S.T. Myers – Twelfth Synthesis Imaging Workshop, June 8, 2010



Coherency vector and Stokes vector

- Maps (perfect) visibilities to the Stokes vector \mathbf{s}
- Example: circular polarization (e.g. VLA)

$$\vec{v}_{circ} = \mathbf{S}_{circ} \vec{S} = \begin{pmatrix} v^{RR} \\ v^{RL} \\ v^{LR} \\ v^{LL} \end{pmatrix} = \begin{pmatrix} 1 & 0 & 0 & 1 \\ 0 & 1 & i & 0 \\ 0 & 1 & -i & 0 \\ 1 & 0 & 0 & -1 \end{pmatrix} \begin{pmatrix} I \\ Q \\ U \\ V \end{pmatrix} = \begin{pmatrix} I+V \\ Q+iU \\ Q-iU \\ I-V \end{pmatrix}$$

- Example: linear polarization (e.g. ALMA, ATCA)

$$\vec{v}_{lin} = \mathbf{S}_{lin} \vec{S} = \begin{pmatrix} v^{XX} \\ v^{XY} \\ v^{YX} \\ v^{YY} \end{pmatrix} = \begin{pmatrix} 1 & 1 & 0 & 0 \\ 0 & 0 & 1 & i \\ 0 & 0 & 1 & -i \\ 1 & -1 & 0 & 0 \end{pmatrix} \begin{pmatrix} I \\ Q \\ U \\ V \end{pmatrix} = \begin{pmatrix} I+Q \\ U+iV \\ U-iV \\ I-Q \end{pmatrix}$$

Corruptions: Jones Matrices

- Antenna-based corruptions
 - pre-correlation polarization-dependent effects act as a matrix multiplication. This is the Jones matrix:

$$\vec{E}^{out} = \mathbf{J} \vec{E}^{in} \quad \mathbf{J} = \begin{pmatrix} J_{11} & J_{12} \\ J_{21} & J_{22} \end{pmatrix} \quad \vec{E} = \begin{pmatrix} E_1 \\ E_2 \end{pmatrix}$$

- form of \mathbf{J} depends on basis (RL or XY) and effect
 - off-diagonal terms J_{12} and J_{21} cause corruption (mixing)
- total \mathbf{J} is a string of Jones matrices for each effect

$$\mathbf{J} = \mathbf{J}_F \mathbf{J}_E \mathbf{J}_D \mathbf{J}_P$$

- Faraday, polarized beam, leakage, parallactic angle

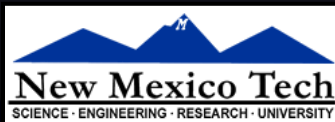

S.T. Myers – Twelfth Synthesis Imaging Workshop, June 8, 2010



Parallactic Angle, P

- Orientation of sky in telescope's field of view
 - Constant for equatorial telescopes
 - Varies for alt-az telescopes
 - Rotates the position angle of linearly polarized radiation (R-L phase)

$$\mathbf{J}_P^{RL} = \begin{pmatrix} e^{i\phi} & 0 \\ 0 & e^{-i\phi} \end{pmatrix}; \quad \mathbf{J}_P^{XY} = \begin{pmatrix} \cos \phi & -\sin \phi \\ \sin \phi & \cos \phi \end{pmatrix}$$

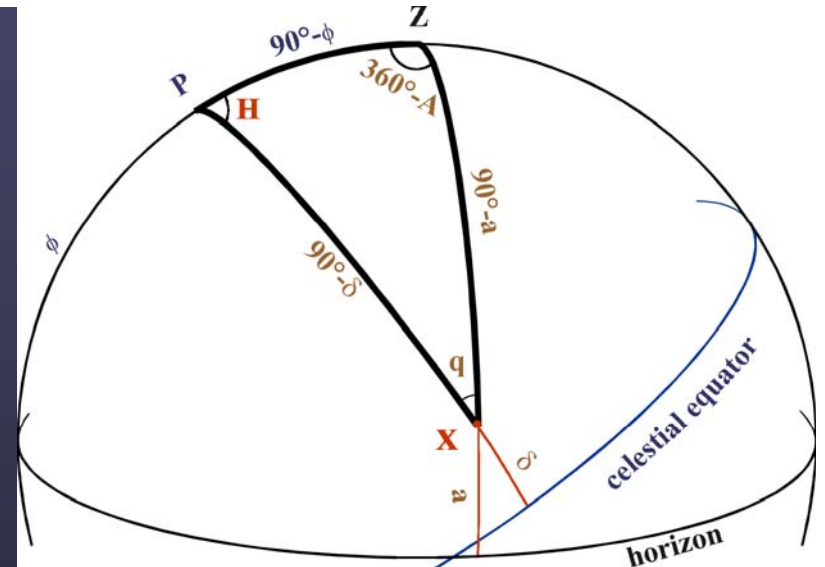

- defined per antenna (often same over array)

$$\phi(t) = \arctan \left(\frac{\cos(l) \sin(h(t))}{\sin(l) \cos(\delta) - \cos(l) \sin(\delta) \cos(h(t))} \right)$$

l = latitude, $h(t)$ = hour angle, δ = declination

- P modulation can be used to aid in calibration

Visibilities to Stokes on-sky: RL basis

- the (outer) products of the parallactic angle (P) and the Stokes matrices gives

$$\vec{v} = \mathbf{J}_P \mathbf{S} \vec{s}$$

- this matrix maps a sky Stokes vector to the coherence vector representing the four perfect (circular) polarization products:

$$\begin{pmatrix} v^{RR} \\ v^{RL} \\ v^{LR} \\ v^{LL} \end{pmatrix} = \begin{pmatrix} e^{-i(\phi_i - \phi_j)} & 0 & 0 & e^{-i(\phi_i - \phi_j)} \\ 0 & e^{-i(\phi_i + \phi_j)} & ie^{-i(\phi_i + \phi_j)} & 0 \\ 0 & e^{i(\phi_i + \phi_j)} & -ie^{i(\phi_i + \phi_j)} & 0 \\ e^{i(\phi_i - \phi_j)} & 0 & 0 & -e^{i(\phi_i - \phi_j)} \end{pmatrix} \begin{pmatrix} I \\ Q \\ U \\ V \end{pmatrix} \xrightarrow{\phi_i = \phi_j = \phi} \begin{pmatrix} I + V \\ (Q + iU)e^{-i2\phi} \\ (Q - iU)e^{i2\phi} \\ I - V \end{pmatrix}$$

Circular Feeds: linear polarization in cross hands, circular in parallel-hands

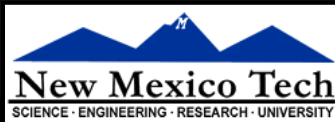

S.T. Myers – Twelfth Synthesis Imaging Workshop, June 8, 2010



Visibilities to Stokes on-sky: XY basis

- we have

$$\begin{pmatrix} v^{XX} \\ v^{XY} \\ v^{YX} \\ v^{YY} \end{pmatrix} = \begin{pmatrix} \cos(\phi_i - \phi_j) & \cos(\phi_i + \phi_j) & -\sin(\phi_i + \phi_j) & i \sin(\phi_i - \phi_j) \\ -\sin(\phi_i - \phi_j) & \sin(\phi_i + \phi_j) & \cos(\phi_i + \phi_j) & i \cos(\phi_i - \phi_j) \\ \sin(\phi_i - \phi_j) & \sin(\phi_i + \phi_j) & \cos(\phi_i + \phi_j) & -i \cos(\phi_i - \phi_j) \\ \cos(\phi_i - \phi_j) & -\cos(\phi_i + \phi_j) & -\sin(\phi_i + \phi_j) & i \sin(\phi_i - \phi_j) \end{pmatrix} \begin{pmatrix} I \\ Q \\ U \\ V \end{pmatrix}$$

- and for identical parallactic angles ϕ between antennas:

$$\begin{pmatrix} v^{XX} \\ v^{XY} \\ v^{YX} \\ v^{YY} \end{pmatrix} \xrightarrow{\phi_i = \phi_j = \phi} \begin{pmatrix} I + Q \cos 2\phi - U \sin 2\phi \\ Q \sin 2\phi + U \cos 2\phi + iV \\ Q \sin 2\phi + U \cos 2\phi - iV \\ I - Q \cos 2\phi + U \sin 2\phi \end{pmatrix}$$

Linear Feeds:
linear polarization
present in all hands

circular polarization
only in cross-hands

Basic Interferometry equations

- An interferometer naturally measures the transform of the sky intensity in uv -space convolved with aperture
 - cross-correlation of aperture voltage patterns in uv -plane
 - its transform on sky is the primary beam \mathbf{A} with FWHM $\sim \lambda/D$

$$\begin{aligned} V(\mathbf{u}) &= \int d^2\mathbf{x} A(\mathbf{x} - \mathbf{x}_p) I(\mathbf{x}) e^{-2\pi i \mathbf{u} \cdot (\mathbf{x} - \mathbf{x}_p)} + \mathbf{n} \\ &= \int d^2\mathbf{v} \tilde{A}(\mathbf{u} - \mathbf{v}) \tilde{I}(\mathbf{v}) e^{2\pi i \mathbf{v} \cdot \mathbf{x}_p} + \mathbf{n} \end{aligned}$$

- The “tilde” quantities are Fourier transforms, with convention:

$$\tilde{T}(\mathbf{u}) = \int d^2\mathbf{x} e^{-i2\pi\mathbf{u}\cdot\mathbf{x}} T(\mathbf{x}) \quad \mathbf{x} = (l, m) \leftrightarrow \mathbf{u} = (u, v)$$

$$T(\mathbf{x}) = \int d^2\mathbf{u} e^{i2\pi\mathbf{u}\cdot\mathbf{x}} \tilde{T}(\mathbf{u})$$

Polarization Interferometry : Q & U

- Parallel-hand & Cross-hand correlations (circular basis)
 - visibility k (antenna pair ij , time, pointing x , channel v , noise n):

$$V_k^{RR}(\mathbf{u}_k) = \int d^2\mathbf{v} \tilde{A}_k^{RR}(\mathbf{u}_k - \mathbf{v}) [\tilde{I}_v(\mathbf{v}) + \tilde{V}_v(\mathbf{v})] e^{2\pi i \mathbf{v} \cdot \mathbf{x}_k} + \mathbf{n}_k^{RR}$$

$$V_k^{RL}(\mathbf{u}_k) = \int d^2\mathbf{v} \tilde{A}_k^{RL}(\mathbf{u}_k - \mathbf{v}) [\tilde{Q}_v(\mathbf{v}) + i\tilde{U}_v(\mathbf{v})] e^{-i2\phi_k} e^{2\pi i \mathbf{v} \cdot \mathbf{x}_k} + \mathbf{n}_k^{RL}$$

$$V_k^{LR}(\mathbf{u}_k) = \int d^2\mathbf{v} \tilde{A}_k^{LR}(\mathbf{u}_k - \mathbf{v}) [\tilde{Q}_v(\mathbf{v}) - i\tilde{U}_v(\mathbf{v})] e^{i2\phi_k} e^{2\pi i \mathbf{v} \cdot \mathbf{x}_k} + \mathbf{n}_k^{LR}$$

$$V_k^{LL}(\mathbf{u}_k) = \int d^2\mathbf{v} \tilde{A}_k^{LL}(\mathbf{u}_k - \mathbf{v}) [\tilde{I}_v(\mathbf{v}) - \tilde{V}_v(\mathbf{v})] e^{2\pi i \mathbf{v} \cdot \mathbf{x}_k} + \mathbf{n}_k^{LL}$$

- where kernel A is the aperture cross-correlation function, ϕ is the parallactic angle, and $\mathbf{Q} + i\mathbf{U} = \mathbf{P}$ is the complex linear polarization

$$\tilde{P}(\mathbf{v}) = \tilde{Q}(\mathbf{v}) + i\tilde{U}(\mathbf{v}) = |\tilde{P}(\mathbf{v})| e^{i2\phi(\mathbf{v})}$$

- the phase of \mathbf{P} is ϕ (the R-L phase difference)

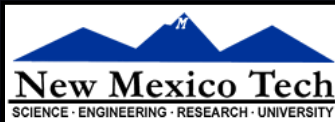

S.T. Myers – Twelfth Synthesis Imaging Workshop, June 8, 2010



Example: RL basis imaging

- Parenthetical Note:
 - can make a pseudo-I image by gridding RR+LL on the Fourier half-plane and inverting to a real image
 - can make a pseudo-V image by gridding RR-LL on the Fourier half-plane and inverting to real image
 - can make a pseudo-(Q+iU) image by gridding RL to the full Fourier plane (with LR as the conjugate) and inverting to a complex image
 - does not require having full polarization RR,RL,LR,LL for every visibility (unlike calibration/correction of visibilities)
- More on imaging (& deconvolution) tomorrow!

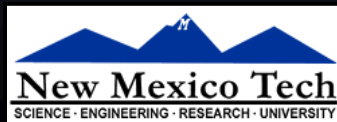

S.T. Myers – Twelfth Synthesis Imaging Workshop, June 8, 2010



Polarization Leakage, D

- Polarizer is not ideal, so orthogonal polarizations not perfectly isolated
 - Well-designed systems have $d < 1\text{-}5\%$ (but some systems $>10\%$ ☹)
 - A geometric property of the antenna, feed & polarizer design
 - frequency dependent (e.g. quarter-wave at center ν)
 - direction dependent (in beam) due to antenna
 - For R,L systems
 - parallel hands affected as $d \cdot Q + d \cdot U$, so only important at high dynamic range (because $Q, U \sim d$, typically)
 - cross-hands affected as $d \cdot I$ so almost always important

$$\mathbf{J}_D^{pq} = \begin{pmatrix} 1 & d^p \\ d^q & 1 \end{pmatrix}$$

Leakage of q into p
(e.g. L into R)

Leakage revisited...

- Primary on-axis effect is “leakage” of one polarization into the measurement of the other (e.g. $R \Leftrightarrow L$)
 - but, direction dependence due to polarization beam!
- Customary to factor out on-axis leakage into D and put direction dependence in “beam”
 - example: expand RL basis with on-axis leakage

$$\hat{V}_{ij}^{RR} = V_{ij}^{RR} + d_i^R V_{ij}^{LR} + d_j^{*R} V_{ij}^{RL} + d_i^R d_j^{*R} V_{ij}^{LL}$$
$$\hat{V}_{ij}^{RL} = V_{ij}^{RL} + d_i^R V_{ij}^{LL} + d_j^{*L} V_{ij}^{RR} + d_i^R d_j^L V_{ij}^{LR}$$

– similarly for XY basis

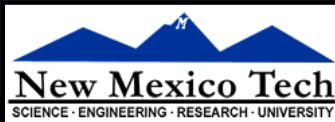

S.T. Myers – Twelfth Synthesis Imaging Workshop, June 8, 2010



Example: RL basis leakage

- In full detail:

$$\begin{aligned}
 V_{ij}^{RR} &= \int_{sky} E_{ij}^{RR}(l, m) [(I + V)e^{i(\chi_i - \chi_j)} \\
 &\quad + d_i^R e^{-i(\chi_i + \chi_j)} (Q - iU) + d_j^{*R} e^{i(\chi_i + \chi_j)} (Q + iU) \\
 &\quad + d_i^R d_j^{*R} e^{-i(\chi_i - \chi_j)} (I - V)](l, m) e^{-i2\pi(u_{ij}l + v_{ij}m)} dldm \\
 V_{ij}^{RL} &= \int_{sky} E_{ij}^{RL}(l, m) [(Q + iU)e^{i(\chi_i + \chi_j)} \\
 &\quad + d_i^R (I - V)e^{-i(\chi_i - \chi_j)} + d_j^{*L} (I + V)e^{i(\chi_i - \chi_j)} \\
 &\quad + d_i^R d_j^{*L} (Q - iU) e^{-i(\chi_i + \chi_j)}](l, m) e^{-i2\pi(u_{ij}l + v_{ij}m)} dldm
 \end{aligned}$$

"true" signal

2nd order:
D•P into I

2nd order:
D²•I into I

1st order:
D•I into P

3rd order:
D²•P* into P

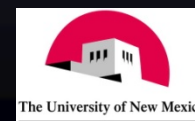
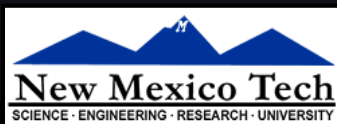

Example: linearized leakage

- RL basis, keeping only terms linear in I, Q±iU, d:

$$V_{ij}^{RL} = (Q + iU)e^{-i(\phi_i + \phi_j)} + I(d_i^R e^{i(\phi_i - \phi_j)} + d_j^{*L} e^{-i(\phi_i - \phi_j)})$$
$$V_{ij}^{LR} = (Q - iU)e^{i(\phi_i + \phi_j)} - I(d_i^L e^{-i(\phi_i - \phi_j)} + d_j^{*R} e^{i(\phi_i - \phi_j)})$$

- Likewise for XY basis, keeping linear in I, Q, U, V, d, sin(ϕ_i-ϕ_j)

$$V_{ij}^{XY} = Q\sin(\phi_i + \phi_j) + U\cos(\phi_i + \phi_j) + iV + [(d_i^X + d_j^{*Y})\cos(\phi_i - \phi_j) - \sin(\phi_i - \phi_j)]I$$
$$V_{ij}^{YX} = Q\sin(\phi_i + \phi_j) + U\cos(\phi_i + \phi_j) + iV + [(d_i^Y + d_j^{*X})\cos(\phi_i - \phi_j) + \sin(\phi_i - \phi_j)]I$$

WARNING: Using linear order will limit dynamic range!
(dropped terms have non-closing properties)

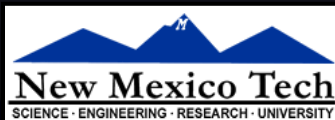

S.T. Myers – Twelfth Synthesis Imaging Workshop, June 8, 2010



Ionospheric Faraday Rotation, F

- Birefringency due to magnetic field in ionospheric plasma

$$\mathbf{J}_F^{RL} = \begin{pmatrix} e^{i\Delta\phi} & 0 \\ 0 & e^{-i\Delta\phi} \end{pmatrix}$$

$$\mathbf{J}_F^{XY} = \begin{pmatrix} \cos \Delta\phi & -\sin \Delta\phi \\ \sin \Delta\phi & \cos \Delta\phi \end{pmatrix}$$

is direction-dependent

$$\Delta\phi \approx 0.15^\circ \lambda^2 \int B_{\parallel} n_e ds$$

(λ in cm, $n_e ds$ in 10^{14} cm^{-2} , B_{\parallel} in G)

$$TEC = \int n_e ds \sim 10^{14} \text{ cm}^{-2}; \quad B_{\parallel} \sim 1\text{G};$$

$$\lambda = 20\text{cm} \rightarrow \Delta\phi \sim 60^\circ$$

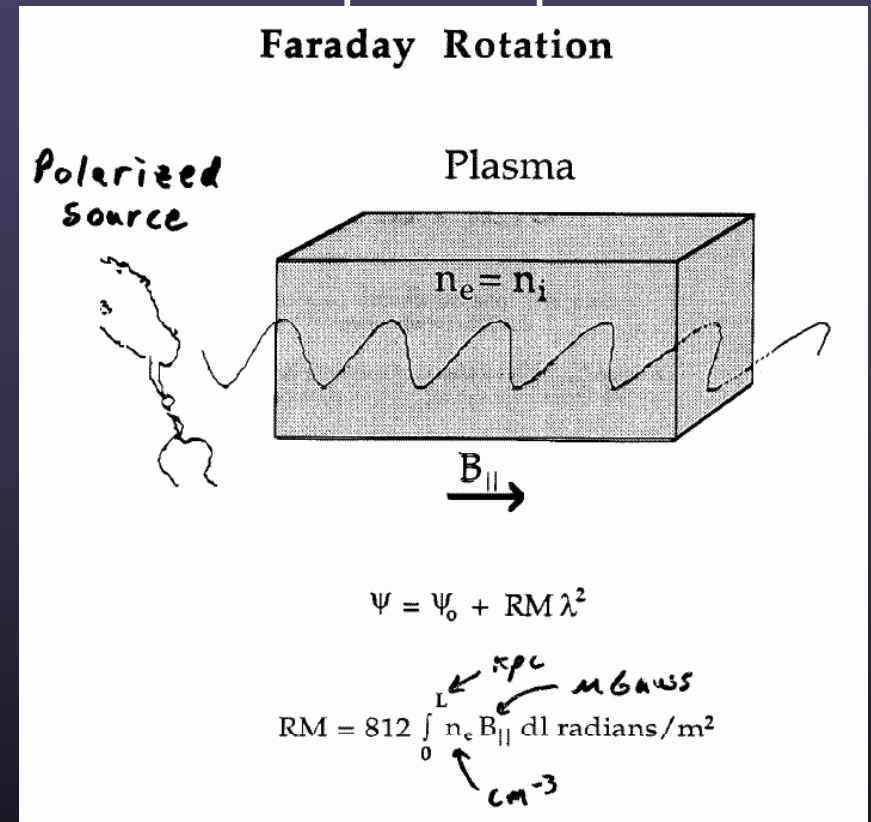

– also present in ISM, IGM and intrinsic to radio sources!

- can come from different Faraday depths \rightarrow tomography

Antenna voltage pattern, E

- Direction-dependent gain and polarization
 - includes primary beam
 - Fourier transform of cross-correlation of antenna voltage patterns
 - includes polarization asymmetry (squint)

$$\mathbf{J}_E^{pq} = \begin{pmatrix} e^{pp}(l', m') & e^{pq}(l', m') \\ e^{qp}(l', m') & e^{qq}(l', m') \end{pmatrix}$$

- includes off-axis cross-polarization (leakage)
 - convenient to reserve D for on-axis leakage
- important in wide-field imaging and mosaicing
 - when sources fill the beam (e.g. low frequency)

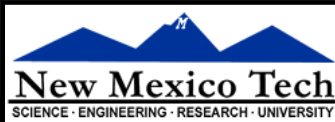

S.T. Myers – Twelfth Synthesis Imaging Workshop, June 8, 2010



Summary – polarization interferometry

- Choice of basis: CP or LP feeds
 - usually a technology consideration
- Follow the signal path
 - ionospheric Faraday rotation F at low frequency
 - direction dependent (and antenna dependent for long baselines)
 - parallactic angle P for coordinate transformation to Stokes
 - antennas can have differing PA (e.g. VLBI)
 - “leakage” D varies with ν and over beam (mix with E)
- Leakage
 - use full (all orders) D solver when possible
 - linear approximation OK for low dynamic range
 - beware when antennas have different parallactic angles

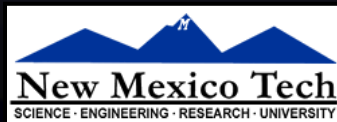

S.T. Myers – Twelfth Synthesis Imaging Workshop, June 8, 2010



Polarization Calibration & Observation

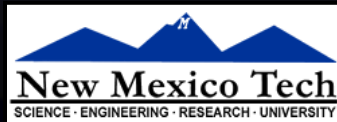

S.T. Myers – Twelfth Synthesis Imaging Workshop, June 8, 2010



So you want to make a polarization image...

- Making polarization images
 - follow general rules for imaging
 - image & deconvolve I, Q, U, V planes
 - Q, U, V will be positive and negative
 - V image can often be used as check (if no intrinsic V-pol)
- Polarization vector plots
 - EVPA calibrator to set angle (e.g. R-L phase difference)
 - $\Phi = \frac{1}{2} \tan^{-1} U/Q$ for E vectors
 - B vectors \perp E
 - plot E vectors (length given by P)
- Leakage calibration is essential
- See Tutorials on Friday

e.g Jupiter 6cm continuum

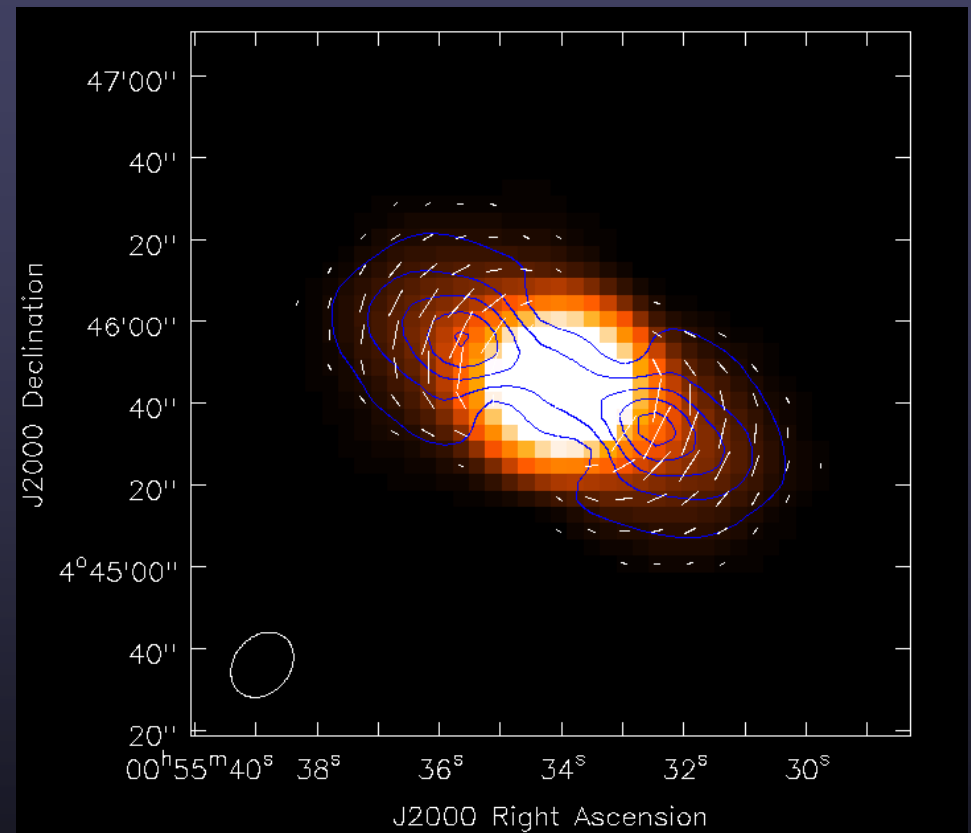

Strategies for leakage calibration

- Need a bright calibrator! Effects are low level...
 - determine antenna gains independently (mostly from parallel hands)
 - use cross-hands (mostly) to determine leakage
 - however, cross-hand leakage insufficient to correct parallel-hands
 - do matrix solution to go beyond linear order
- Calibrator is unpolarized
 - leakage directly determined (ratio to \mathbf{I} model), but only to an overall complex constant (additive over array)
 - need way to fix phase $\delta_p - \delta_q$ (*ie.* R-L phase difference), e.g. using another calibrator with known EVPA
- Calibrator of known (non-zero) linear polarization
 - leakage can be directly determined (for I,Q,U,V model)
 - for a single scan only within an overall offset (e.g. sum of D-terms)
 - unknown p - q phase can be determined (from U/Q etc.)

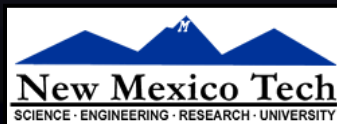

S.T. Myers – Twelfth Synthesis Imaging Workshop, June 8, 2010

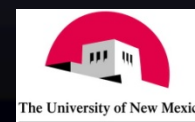

Other strategies

- Calibrator of unknown polarization
 - solve for model $IQUV$ and D simultaneously or iteratively
 - need good parallactic angle coverage to modulate sky and instrumental signals
 - in instrument basis, sky signal modulated by $e^{i2\chi}$
- With a very bright strongly polarized calibrator
 - can solve for leakages and polarization per baseline
 - can solve for leakages using parallel hands!
- With no calibrator
 - hope it averages down over parallactic angle
 - transfer D from a similar observation
 - usually possible for several days, better than nothing!
 - need observations at same frequency

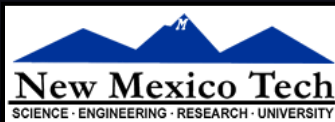

S.T. Myers – Twelfth Synthesis Imaging Workshop, June 8, 2010



Parallactic Angle Coverage at VLA

- fastest PA swing for source passing through zenith
 - to get good PA coverage in a few hours, need calibrators between declination $+20^\circ$ and $+60^\circ$

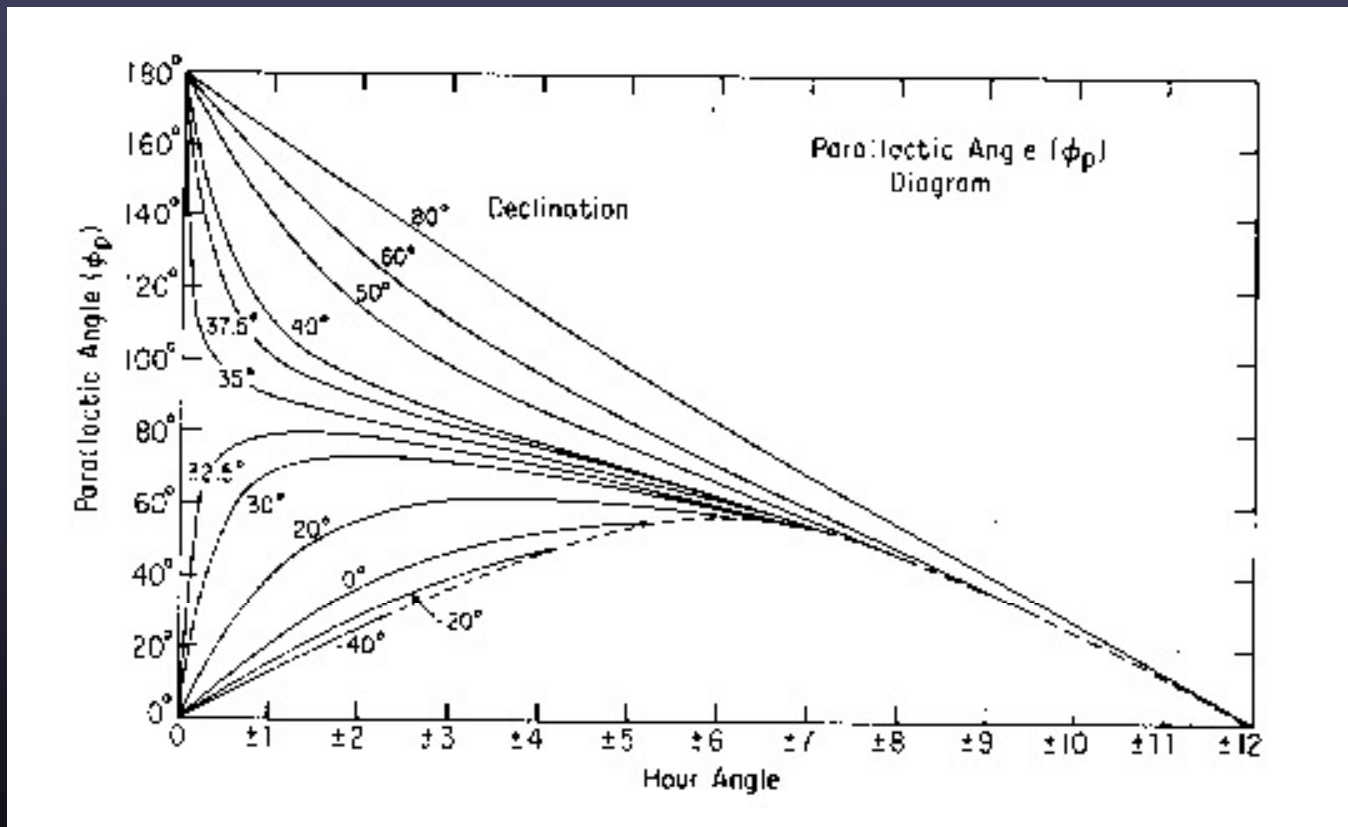

Finding polarization calibrators

- Standard sources
 - planets (unpolarized if unresolved)
 - 3C286, 3C48, 3C147 (known IQU, stable)
 - sources monitored (e.g. by VLA)
 - other bright sources (bootstrap)

<http://www.vla.nrao.edu/astro/calib/polar/>

The screenshot shows the VLA/VLBA Polarization Calibration Page, which is a table of calibration sources. The table is organized into sections for different frequency bands: 2136+006, 2202+422 C BAND, and 2253+161 C BAND. Each row represents a source, with columns for its name, polarization type (B, D, A, MEAN), a list of observation IDs (e.g., 20031205, 20031219), and several columns of numerical values representing polarization measurements and their uncertainties. The table also includes a 'MEAN' row for each band, summarizing the average values and uncertainties. The website header identifies the authors as Steve Myers and Greg Taylor at NRAO, Socorro.

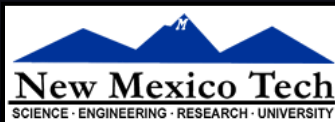

S.T. Myers – Twelfth Synthesis Imaging Workshop, June 8, 2010



Example: VLA D-term calibration

- D-term calibration effect on RL visibilities (should be $Q+iU$):

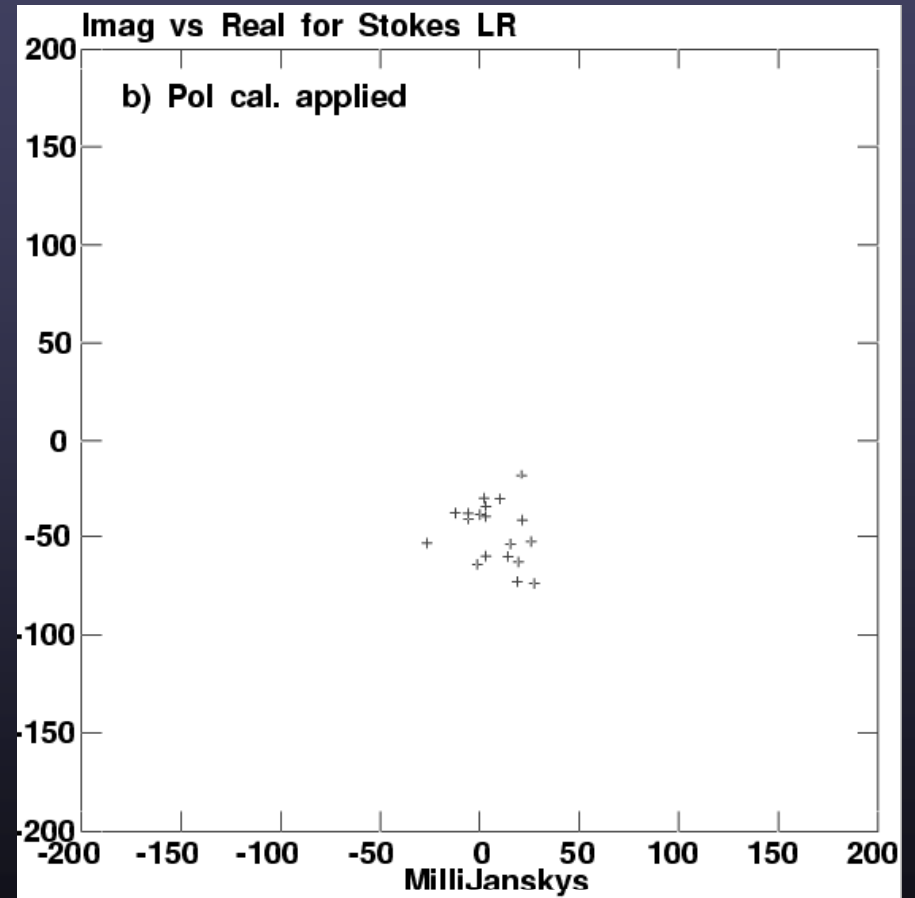
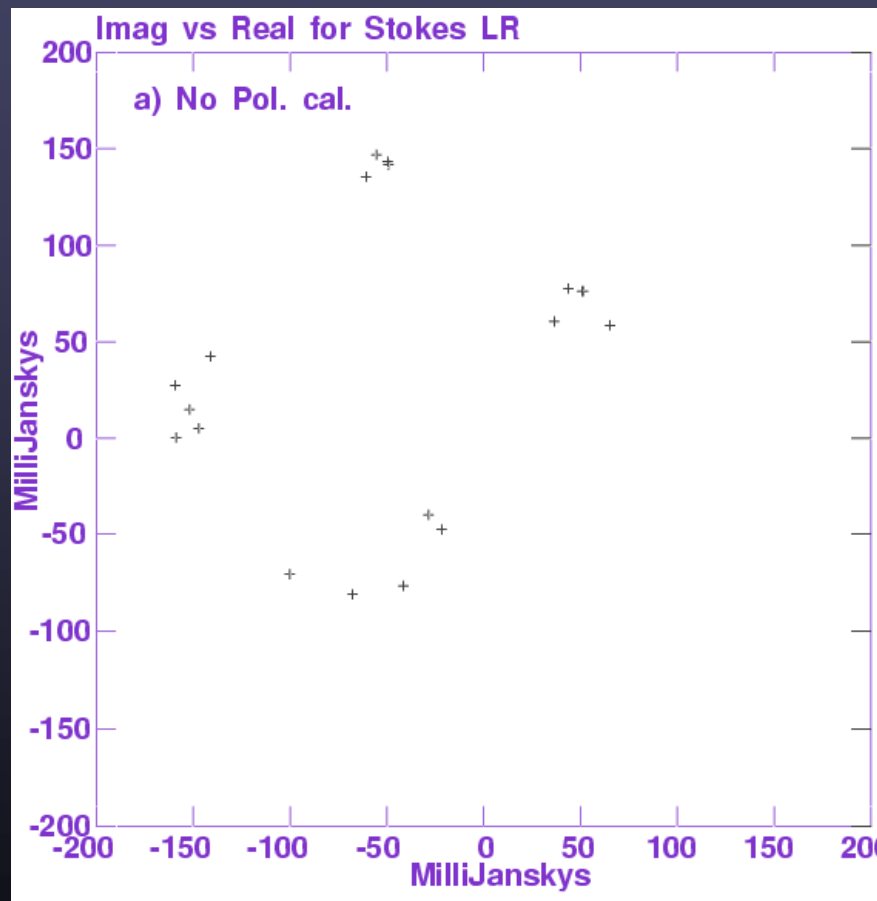

Example: VLA D-term calibration

- D-term calibration effect in Q image plane :

Bad D-term solution

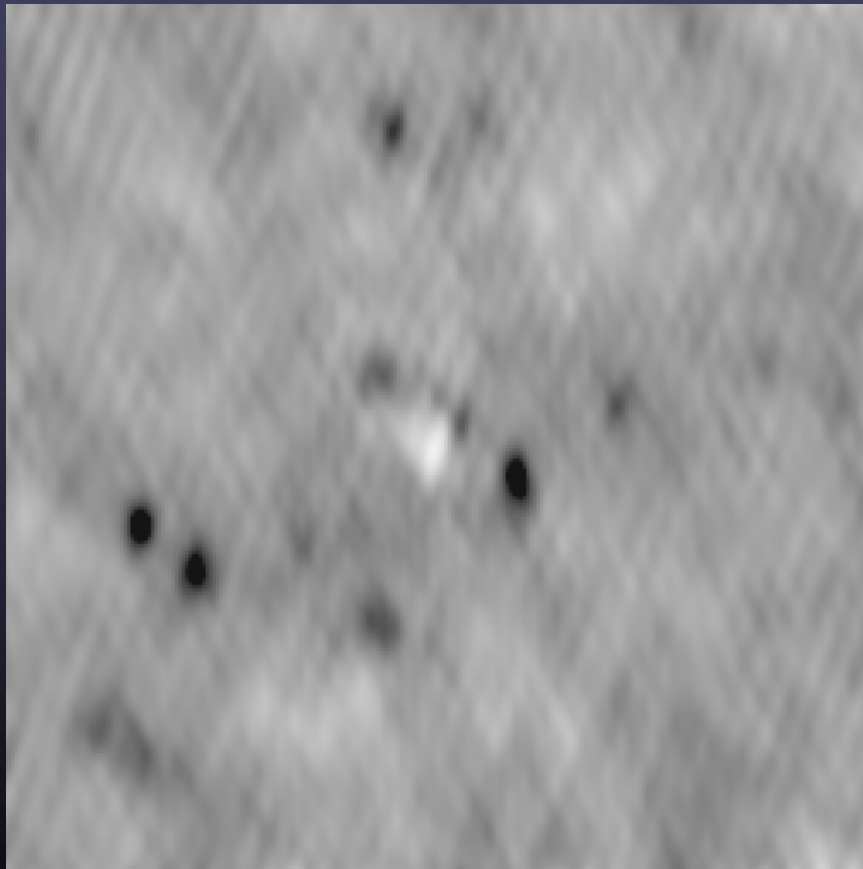

Good D-term solution

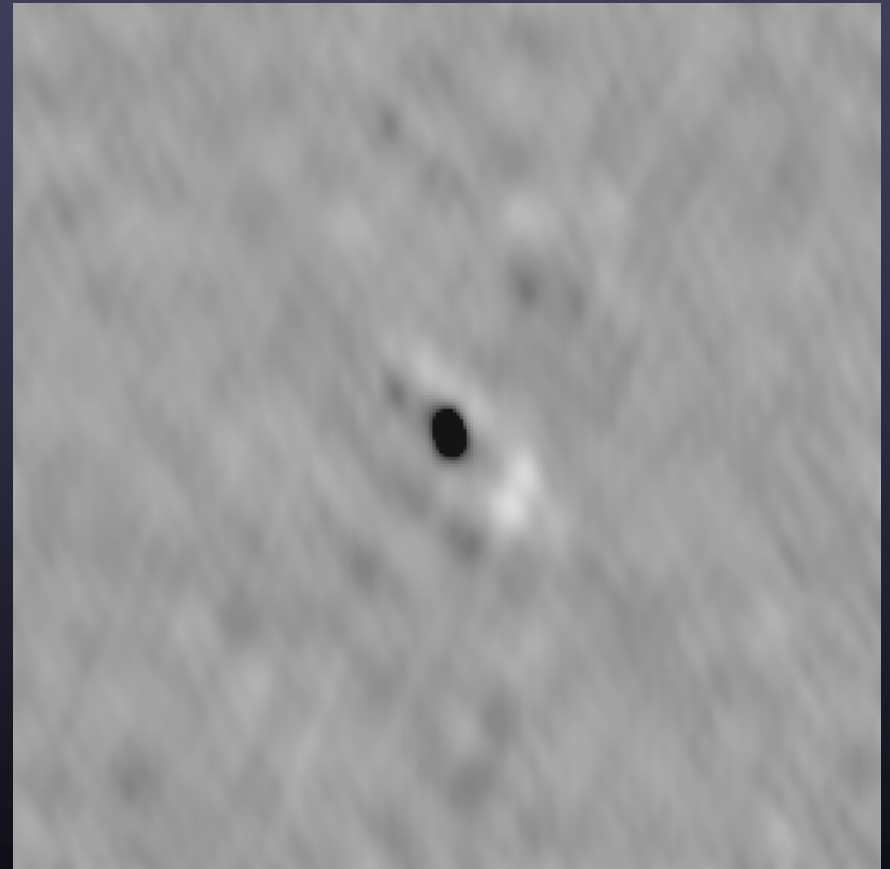

Example: EVLA D-term calibration

- C-band D-term calibration as a function of frequency (OSRO-1 mode):
 - frequency-dependent effects over wide bands, beware of cross-hand delays

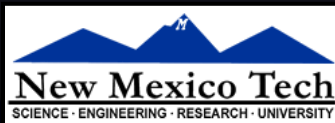
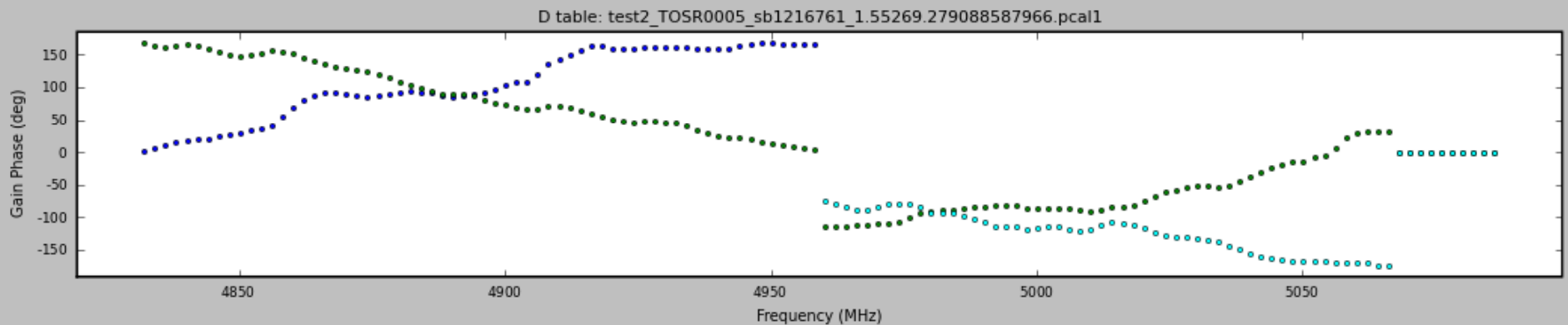
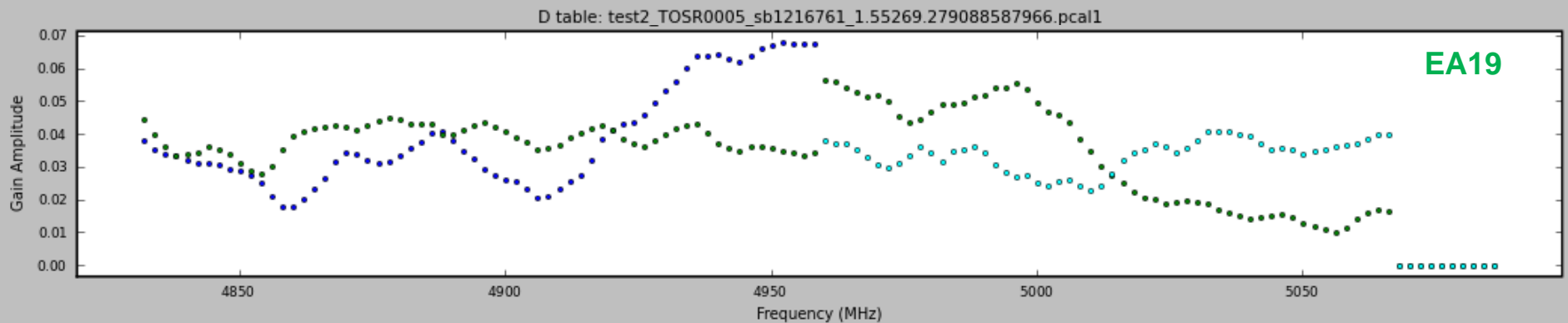

S.T. Myers – Twelfth Synthesis Imaging Workshop, June 8, 2010



Example: EVLA D-term calibration

- C-band D-term calibration as a function of antenna (OSRO-1 mode):

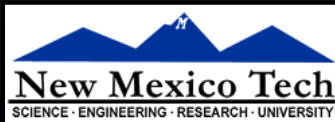
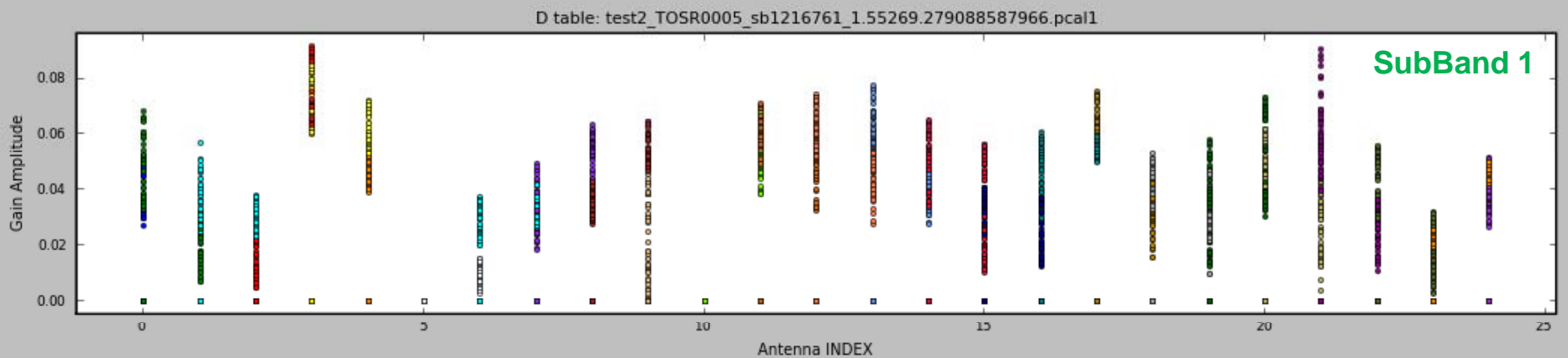
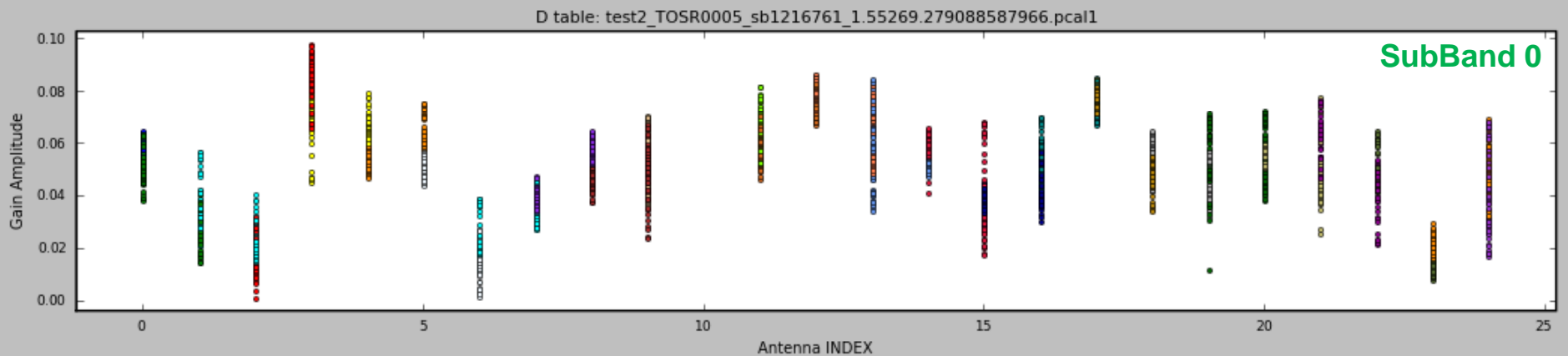

S.T. Myers – Twelfth Synthesis Imaging Workshop, June 8, 2010



Example: EVLA EVPA calibration

- C-band R-L phase as a function of frequency (OSRO-1 mode):
 - solve for single-phase and cross-hand delay over array

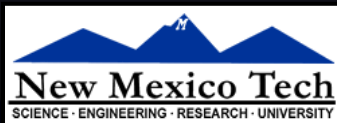
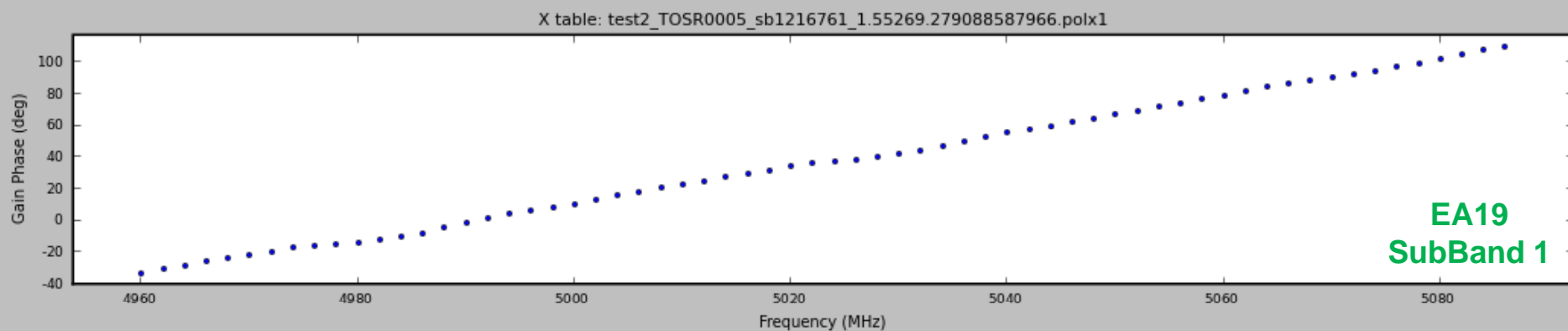
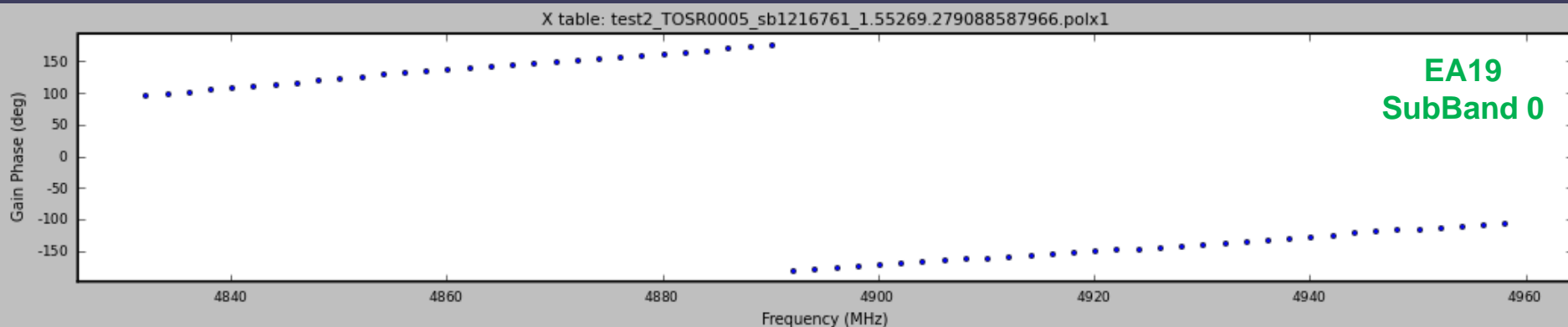

S.T. Myers – Twelfth Synthesis Imaging Workshop, June 8, 2010

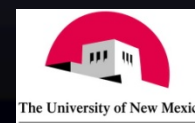

Summary – Observing & Calibration

- Follow normal calibration procedure (see next lecture)
- Need bright calibrator for leakage D calibration
 - bright calibrator with known polarization
 - unpolarized (or very low polarization) sources see only leakage
- Parallactic angle coverage useful
 - necessary for unknown calibrator polarization
- Need to determine unknown p - q phase
 - CP feeds need EVPA calibrator (known strong Q,U) for R-L phase
 - if system stable, can transfer from other observations
- Upshot – build polarization calibration into schedule
 - if you need PA coverage, will be observing near zenith
 - watch antenna wraps (particularly in dynamic scheduling)!

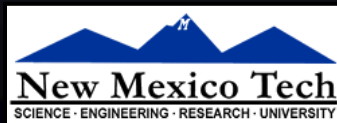

S.T. Myers – Twelfth Synthesis Imaging Workshop, June 8, 2010



Special Considerations – EVLA & ALMA

- Wideband calibration issues
 - D-term and p-q phase corrections as function of frequency
 - need bright source to solve on per-channel basis
- Delay issues
 - parallel-hand delays taken out in bandpass
 - need to remove cross-hand delays in or before Pol calibration
- High-dynamic range issues
 - D-term contribution to parallel-hand correlations (non-closing)
 - wide-field polarization imaging/calibration algorithm development
 - direction-dependent voltage beam patterns needed
- Special issues
 - EVLA circular feeds: observing V difficult
 - ALMA linear feeds: gain calibration interaction

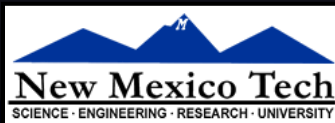

S.T. Myers – Twelfth Synthesis Imaging Workshop, June 8, 2010

